

**MINISTRY OF EDUCATION OF REPUBLIC OF AZERBAIJAN**

**KHAZAR UNIVERSITY**

---

**FACULTY OF SCIENCE AND ENGINEERING NCES**

The code of major 60606 – Oil and Gas Engineering

The name of specialty Petroleum Engineering

**MASTER THESIS**

**Title:** Role of Well Stimulation Methods in the Optimization of Production  
from Oil and Gas Well

Master Student: Murad Asgerov

Supervisor: Associate Prof. Dr. Gasham Zeynalov

BAKU – 2019

## **Abstract**

Stimulation methods can be used in production, discovery and appraisal wells. The purpose of stimulation is to restore or enhance the delivery of hydrocarbons to the wellbore. Wellbore will halt the production of the hydrocarbons after perforating because permeability has been decreased and wellbore region has been damaged due to specific reason. In a general case, it can be called as formation damage. Well tests is applied to measure production rates from a well and estimate the stimulation methods compatibility. Stimulation treatments has to be done for the cased hole. If we apply stimulation methods into the open hole open, borehole collapse and packer leaks will occur. Reservoir stimulation accomplishes this primarily by restoring, improving, increasing or otherwise modifying the permeability of the target formation.

Types of stimulations which are utilized to maximize well's productivity are below:

- Matrix acidizing: In this method, acid is pumped into wellbore but this is not high pressure acid to create channels as HF treatment fluid.. This acid helps to dissolve the rock around the well bore which have blocked the perforations. These acid enlarges the channels.
- Hydraulic fracturing: This stimulation method involves pumping high pressure mixtures which contribuites to create high permeability channels.
- Acid fracturing: This is used to form high conductivity channels in near wellbore area which are having high permeability channels in the carbonate rocks

In this thesis, the key aspects of the hydraulic fracturing and matrix acidizing, such as their mechanics, geometry and design are reviewed. Predominantly, the key challenges and motivation behind the process are mentioned, and the principal objectives of the following experiments have been identified. The theoretical knowledge on the hydraulic fracturing and matrix acidizing, its impact on maintaining of fractures, the mechanics of fractures, related industry challenges, several types of stimulations and innovations are talked over in one of the chapters.

## Xülasə

Stimulasiya metodlar istismar, kəşf və qiymətləndirmə quyularında istifadə edilə bilər. Stimulasiyanın məqsədi karbohidrogenlərin quyuya çatdırılmasını bərpa etmək və ya artırmaqdır. Quyudibində perforasiya olunduqdan sonra həmin zona keçiriciliyin azalması və quyudibi zoonanın zədələnməsi səbəbindən hasilatı dayandırır. Ümümi halda bu formasiyanın zədələnməsi də adlandırıla bilər. Quyudan gələn fluidin iqtisadi istismar sürətini qurmaq üçün quyu testlərinə istifadə olunacaq. Stimulasiyanın aradan qaldırılması həmçinin qoruyucu kəmərlə bərkidilmiş quyularda da edilə bilər. Əgər biz bu stimulasiya metodlarını açıq lülədə tətbiq etsək, quyu divarının uçması və pakerin sızması kimi problemlər baş verə bilər.

Quyunun məhsuldarlığını maksimallaşdırmaq üçün istifadə olunan stimulasiya metodları aşağıdakılardır:

Turşu ilə işləmə: bu metodda turşu quyuya vurulur lakin bu hidravlik yarıqlaşdırma metodundakı kimi yüksək təzyiqli maye deyil. Bu maye quyudibində perforasiyaların və kanalların keçiriciliyinin azalmasına səbəb olan süxurları həll edir. Bu maye həmçinin quyudibi kanalları genişləndirir.

Hidravliki yarıqlaşdırma: Stimulasiyanın bu növü yüksək təzyiqli qatışıqın quyudibi zonaya vurulması ilə orada yüksək keçiricili kanalların yaradılmasıdır.

Turşu yarıqlaşdırma: Bu metod da karbonatlı süxurlarda yüksək təzyiqli turşu məhlulunun quyuya vurulması ilə orada yüksək keçiriciliyə malik olan kanalların yaradılmasıdır. Bu tezisdə hidravliki yarıqlaşdırma və turşu ilə işləmənin açar aspektləri mexanika və geometriyası əks olunub. Və həmçinin bu metodların məqsədləri və hər birinə aid eksperimentlər, simulasiyalar müəyyənləşdirilib. Eksperimentlərin sonunda, nəticələr elektron tablo şəklində əldə edilir və daha sonra qrafik şəklində təqdim olunurlar.

## Contents

List of figures .....	ix
List of tables .....	xi
Nomenclature.....	xii
List of abbreviations.....	xiii
Introduction.....	15
CHAPTER 1. Preferences of Horizontal Well on Vertical wells.....	17
1.1. Artificial lift methods.....	18
1.2. Factors affect the selection of Artificial lift.....	20
CHAPTER 2. Mechanism of the Formation Damage.....	21
2.1. Origins of Formation damage.....	21
2.2. Determination of the formation damage.....	28
2.2. Evaluation of the Skin factor.....	29
CHAPTER 3. Matrix Acidizing.....	31
3.1. To prepare the well before acidizing.....	31
3.2. Acid treatment design.....	32
3.3. Acid selection in sandstone and carbonate reservoirs.....	33
3.4. Matrix acidizing in the sandstone reservoirs.....	34
3.5. Analysis of the Acid Response Curve.....	35

3.6. Selection of the injection rate and acid volume.....	36
3.7. Ranges of the additives used in the treatment fluid.....	37
CHAPTER 4. Hydraulic Fracturing.....	39
4.1. Fracturing Pressure.....	40
4.2. Description of the tip screen-out screen.....	41
4.3. Stress state for the mechanism of hydraulic fracturing.....	41
4.4. Fracture Geometry.....	43
4.5. 2D - Perkins-Kern Nordgren (PKN).....	43
4.6. The Khristianovic-Geertsma-de Klerk(KGD) model.....	45
4.7. 3D fracture design models.....	46
4.8. Fracture Height.....	47
4.9. Selection of design of the hydraulic fracturing treatment.....	48
4.10. Types of proppants and the hydraulic fracturing additives.....	50
CHAPTER 5. Research methodology.....	53
5.1. Data for hydraulic Fracturing.....	57
Conclusions-----	95
References-----	97

## List of Figures

Fig 1. Scheme of horizontal well [1].....	17
Fig 2. Artificial lift methods [4].....	5
Fig.3.Dependence between filter cake permeability and rate of invasion [11].....	22
Fig.4. Effect of thin filter cake in less formation damage [11].....	22
Fig.5. Insufficient perforation due to overgauge hole [6].....	24
Fig.6. Formation damage formed during perforating [3].....	25
Fig.7. Blockage inside tubing by scale precipitation [3].....	26
Fig.8. Solids entrainment into a pore system [10].....	28
Fig.9. Log determine the zone having formation damage [3].....	29
Fig.10. Effect of the skin on pressure profile [3].....	30
Fig 11. Acid response curve[12].....	36
Fig .12. Pressure behavior in fracturing [6].....	41
Fig.13. Tip Screen-out technique [17].....	42
Fig.14. Stress anisotropy around the borehole[16].....	43
Fig.15. Description of the fracture geometry [16].....	44
Fig.16. View of the PKN model [18].....	45
Fig.17. View of KGD model [18].....	47
Fig.18. Width and height combination in P3D model (L) Length and height connection in P3D model [18].....	48

Fig.19. Necessity of the fracture height [19].....	49
Fig.20. Major sources of data [16].....	50
Fig.21. Proppant types and their characterization [20].....	52
Fig.22. Gas Production Rate in different tubing diameter sizes.....	59
Fig.23. Oil Production Rate in different tubing diameter sizes.....	60
Fig.24. Water Production Rate in different tubing diameter sizes. ....	61
Fig.25. Liquid Production Rate in different tubing diameter sizes. ....	62
Fig.26. Gas Production Rates in different skin factor values.....	63
Fig.27. Oil Production Rates in different skin factor values.....	64
Fig.28. Water Production Rates in different tubing diameter sizes in 30 angle inclination. ....	65
Fig.29. Liquid Production Rates in different tubing diameter sizes in 30 angle inclination.....	66
Fig.30. Gas Production Rates in different tubing diameter sizes in 30 angle inclination.....	67
Fig.31. Oil Production Rates in different tubing diameter sizes in 30 angle inclination.. ....	68
Fig.32. Water Production Rates in different skin factor values in 30 angle inclination.....	69
Fig.33. Liquid Production Rates in different skin factor values in 30 angle inclination.....	70

Fig.34. Gas Production Rates in different skin factor values in 30 angle inclination.....	71
Fig.35. Oil Production Rates in different skin factor values in 30 angle inclination.....	72
Fig.36. Water Production Rates in different tubing diameter sizes in 45 angle inclination.....	73
Fig.37. Liquid Production Rates in different tubing diameter sizes in 45 angle inclination.....	74
Fig.38. Gas Production Rates in different tubing diameter sizes in 45 angle inclination. ....	75
Fig.39. Oil Production Rates in different tubing diameter sizes in 45 angle inclination.....	76.
Fig.40. Water Production Rates in different skin factor values in 45 angle inclination.....	77
Fig.41. Liquid Production Rates in different skin factor values in 45 angle inclination.....	78
Fig.42. Gas Production Rates in different skin factor values in 45 angle inclination.....	79
Fig.43. Oil Production Rates in different skin factor values in 45 angle inclination..	80
Fig.44. Water Production Rates in tubing diameter sizes in 60 angle inclination.....	81
Fig.45. Liquid Production Rates in tubing diameter sizes in 60 angle inclination.....	82



Fig.46. Gas Production Rates in tubing diameter sizes in 60 angle inclination.....83

Fig.47. Oil Production Rates in tubing diameter sizes in 60 angle inclination.....84

Fig.48. Water Production Rates in skin factor values in 60 angle inclination.....85

Fig.49. Liquid Production Rates in skin factor values in 60 angle inclination.....86

Fig.50. Gas Production Rates in skin factor values in 60 angle inclination.....87

Fig.51. Oil Production Rates in skin factor values in 60 angle inclination.....88

Fig.52. Water Production Rates in skin factor values in 60 angle inclination.....89

## List of tables

Table 1. Acidizing stages [12].....	34
Table 2. Description of Acid Treatment [14].....	36
Table 3. Volume of Acid depending on the permeability and temperature [12].....	38
Table 4. Reservoir properties from 287 number well.....	56
Table 5. Match PVT data.....	57
Table 6. Data for hydraulic fracturing.....	58
Table 7. Gas Production Rate in different tubing diameter sizes.....	59
Table 8. Oil Production Rate in different tubing diameter sizes.....	60
Table 9. Water Production Rate in different tubing diameter sizes.....	61
Table 10. Liquid Production Rate in different tubing diameter sizes.....	62
Table 11. Gas Production Rates in different skin factor values.....	63
Table 12. Oil Production Rates in different skin factor values.....	64
Table 13. Water Production Rates in different tubing diameter sizes in 30 angle inclination.....	65
Table 14. Liquid Production Rates in different tubing diameter sizes in 30 angle inclination.....	66
Table 15. Gas Production Rates in different tubing diameter sizes in 30 angle inclination.....	67
Table 16. Oil Production Rates in different tubing diameter sizes in 30 angle inclination.....	68
Table 17. Water Production Rates in different skin factor values in 30 angle inclination.....	69
Table 18. Liquid Production Rates in different skin factor values in 30 angle inclination.....	70
Table 19. Gas Production Rates in different skin factor values in 30 angle.....	71

Table 20. Oil Production Rates in different skin factor values in 30 angle inclination .....	72
Table 21. Water Production Rates in different tubing diameter sizes in 45 angle inclination.....	73
Table 22. Liquid Production Rates in different tubing diameter sizes in 45 angle inclination.....	74
Table 23. Gas Production Rates in different tubing diameter sizes in 45 angle inclination.....	75
Table 24. Oil Production Rates in different tubing diameter sizes in 45 angle inclination.....	76
Table 25. Water Production Rates in different skin factor values in 45 angle inclination.....	77
Table 26. Liquid Production Rates in different skin factor values in 45 angle inclination.....	78
Table 27. Gas Production Rates in different skin factor values in 45 deg inclination.. .....	79
Table 28. Oil Production Rates in different skin factor values in 45 angle inclination.....	80
Table 29. Water Production Rates in tubing diameter sizes in 60 angle inclination.	81
Table 30. Liquid Production Rates in tubing diameter sizes in 60 angle inclination.	82
Table 31. Gas Production Rates in tubing diameter sizes in 60 angle inclination...	83
Table 32. Oil Production Rates in tubing diameter sizes in 60 angle inclination....	84
Table 33. Water Production Rates in skin factor values in 60 angle inclination.....	85
Table 34. Liquid Production Rates in skin factor values in 60 angle inclination....	86

Table 35. Gas Production Rates in skin factor values in 60 angle inclination.....87

Table 36. Oil Production Rates in skin factor values in 60 angle inclination.....88

Table 37. Water Production Rates in skin factor values in 60 angle inclination.....89

## Nomenclature

Symbol	Description	Units
$S_d$	formation damage skin	dimensionless
$k_0$	formation permeability to oil	mD
$k_d$	damaged permeability	mD
$\mu_0$	oil viscosity	sP
$q_0$	oil flow rate	Bbl/day
$\nu$	Poisson's ratio	dimensionless
$i_{max}$	maximum injection rate	Bpm(barrel per minute)
$P_r$	reservoir pressure	psi
$E$	Elasticity modulus	psi
$r_w$	wellbore radius	ft
$P_{fpp}$	fracture propagation pressure	psi
$\Delta P_s$	safety margin	psi
$B_0$	Oil formation volume factor	mD
$\varepsilon_y$	Lateral strain	Dimensionless
$\varepsilon_x$	Longitudinal strain	Dimensionless

## List of abbreviations

Abbreviation	Meaning
CBM	Coal bed methane
EOR	Enhanced oil recovery
KGD	Khristianovic-Geertsma-de Klerk
PKN	The Perkins-Kern-Nordgren
NPV	Net present value
RCS	Resin coated sand
SG	Specific gravity
GOR	Gas Oil Ratio
CFD	Computational fluid dynamics

## Introduction

Oil and gas well is produced for many years without the consumption of well stimulation technique. As an oil and gas well is put on the production, this is at its highest rate from the initial stage. As the time passes by, production reduces by certain reasons, pressure declines. Well stimulation services are utilized to help to restore the original pressure in order to increase production and bring production back up.

In today's society, the demand for oil and gas has rapidly increased, which means production also needs to increase to keep prices affordable and maintain pace with the demand. To do this, new techniques are needed to maximize production. When a well is initially drilled and is put on production, oil production continues without any depletion for years. However, oil and gas drilling introduces foreign materials, such as clay and water. There are two basic types of well stimulation: matrix acidizing and hydraulic fracturing. Well stimulation applies to eliminate the rock debris clogging which led to reduction in formation permeability and the production.

Flow surveys invariably show that a significant interval of near wellbore region in the open or cased hole does not have contribution to the production. According to horizontal permeabilities is being greater than vertical permeabilities, these decreased and limited total production rates and It is goes to result in significant hydrocarbon being left in rocks when the well has come its economic limit. Some part of open and cased hole (perforation part) tends to be unproductive this is an indicator the damaged well which has been caused by careless drilling, production and completion practices and are therefore avoidable. In this way, those methods should be analyzed which can cause to a decrease in the formation permeability. Even if formation damage can seem unavoidable, an understanding of the feature of formation damage can be vital in the choice of suitable methods

for stimulation.

By analyzing the formation damage in the detailed form, bad effects of it in the production can be prevented. Without taking into account in a correct way, it will inevitable to minimize the bad effects. Most formation damage happens in the wellbore region and results primarily from the pores becoming blocked with debris. This debris can be generated from physical, chemical and biological reasons. It can be produced by hydrodynamic forces which strip loosely attached fine particles from pore walls(physical process), it can be produced by contact of injected fluids with reservoir rock(chemical) and it can be product of bacterial activity. It does not mean that all debris which enters into pore spaces will block pore spaces and reduce wellbore permeability and will be occupied on the surface of the pores. Besides, clogging pores have been decreased production, in si-tu emulsification and wettability modifications leads to smaller permeability zones. Enhancement of the oil and gas production is the key motivation of using the well stimulation methods for the last forty years.

## Scope

This research is based on the real date obtained from the field. The purpose of this study/experiment is to show the effectiveness of well stimulation methods in production rate of the each phase. When production drops due to formation damage, well stimulation comes to help. This thesis contributes to understand the matrix acidizing and hydraulic fracturing in a very detailed way. Maximization of oil production by use of stimulation technics was demonstrated in graphs and tables in the later phases of this thesis

## **CHAPTER 1. Preferences of Horizontal Well on Vertical Wells**

For producing more oil gas, the well you are planning to drill should surround larger drainage area. For this purpose, horizontal wells are advantageous than vertical wells.



Horizontal wells are drilled into the reservoir at high angle. These types of the well surround large drainage are in the comparison with vertical wells. Although these wells are named like horizontal but they are seldom drilled horizontally. They tend to be near horizontal. Angle of the well does not equalize to 90, ranging from 80-90 degree. Horizontal wells have various structural arrangements. Mostly their structure becomes like below: Tangent section is drilled through deviated well which is located above the reservoir part. This section is called as kick-off point. From starting kick-off point, the well is drilled at higher angle (approximately 80 degree) close to horizontal. The well starts to enter into target formation from which is called entry point. Length of horizontal leg though the formation depends on the length of the pay zone. [2]

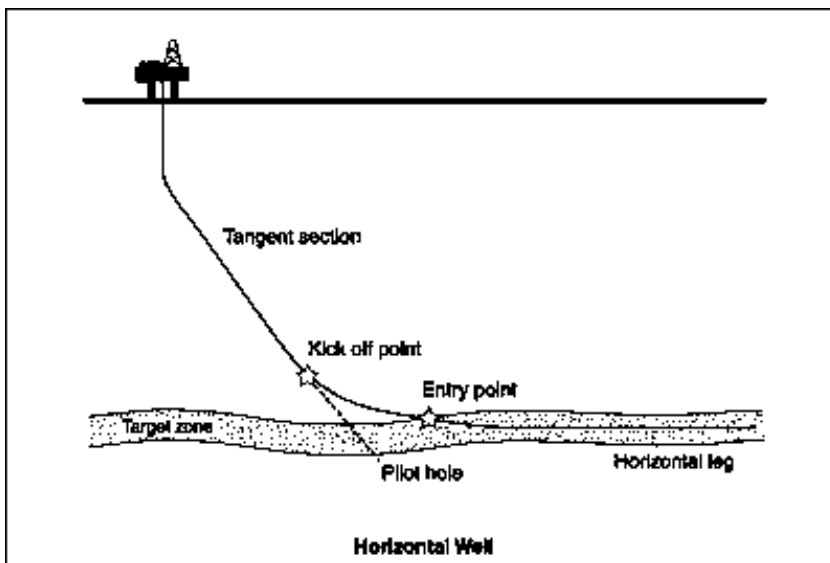

**Figure 1.** Scheme of horizontal well [1]

Information below is why the horizontal wells are preferable than vertical wells:

- 1- Hit targets that cannot be reached by vertical drilling - reservoir is sometimes placed under the populated area or park or in the forest which cutting the trees or placing the rig equipment is forbidden. This type of reservoir is produced by

drilling horizontal or directional well

- 2- Drain a broad area from a single drilling pad – drainage area of horizontal well is larger than vertical well which continues parallel to formation at 10 or longer length. From cost point of view, a number of the wells which are used to produce the formation are reduced by horizontal wells.
- 3- Increase the length of the "pay zone" within the target rock unit – if the formation has 50 feet thickness, production obtained from vertical well through this formation will have 50 feet pay zone. But horizontal well enables us to increase pay zone until 500 feet or more. This will result in great productivity.
- 4- Under the conditions of the naturally fractured reservoir – horizontal well is drilled in the direction of the fractures and surround many fractures. Fractures have aligned in vertical direction from the surface. If the company drills vertical well, it will surround less pay zone and productivity will be low. But horizontal well should be drilled to intersect with fractures which give us significant rise in production. [1]

### **1.1. Artificial methods**

After completion of the discovery well in newly discovered reservoir, hydrocarbons will come to the surface by natural drive mechanism. Reservoir pressure is high enough to bring formation fluid to the surface facilities without the help of additional energy. As the production is going on, reservoir pressure depletes and static formation fluid can not reach to the surface and is below surface. Bottomhole pressure increase and equalize to formation pressure. The lack of drawdown contributes to stop production. Suitable type of artificial lift should be applied to the well to bring a well back to a production. Artificial methods are below: [3]

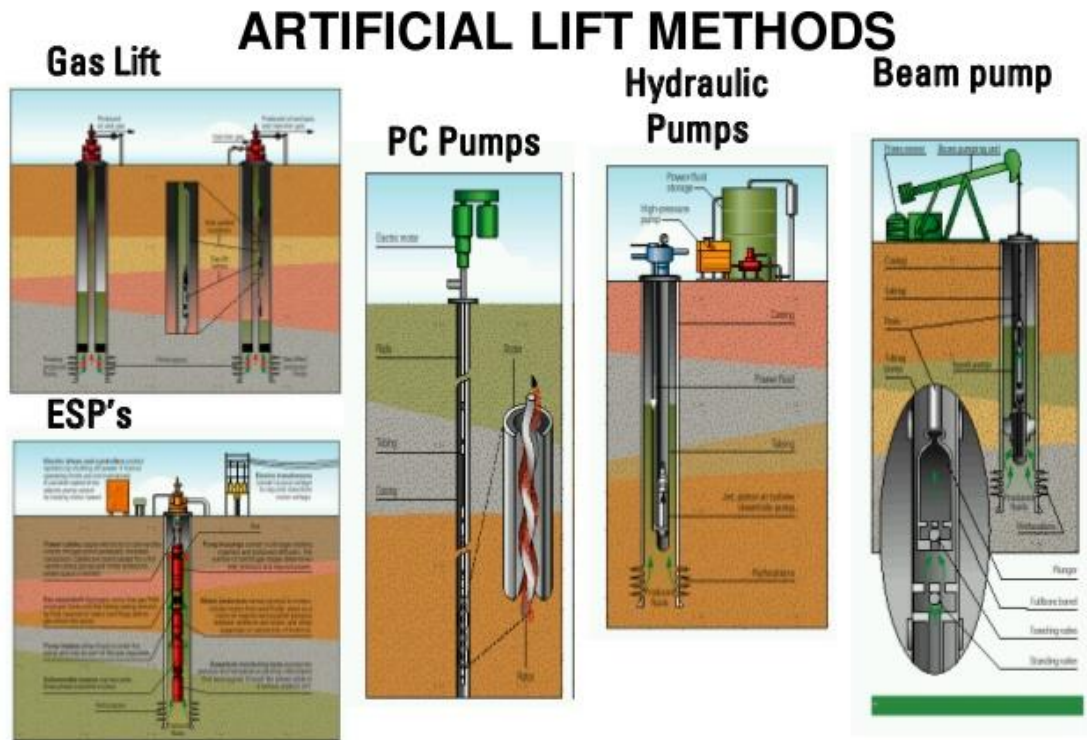

**Figure 2.** Artificial lift methods [4]

**Rod Pumps-** The pump is placed near perforations. It consists of downhole plunger with sealing rings. Plunger is connected to the sucker rods which provided with 2 valves: Standing valve and Travelling vane. While standing vane is located in the bottom part of plunger, travelling vane is put on the top of pump. While the plunger moves in the well, it displaces formation fluid into the tubing and to the surface. While plunger moves down, standing valve is off seat and fluid enters into pump and travelling vane is closed. As the upward movement of the plunger occurs, standing vane is closed, travelling vane is off seat. Formation fluid goes to surface via tubing

**Hydraulic Pumps** use a high pressure power fluid to:

Flow through a venturi or jet, creating a low pressure area which produces an increased drawdown and inflow from the reservoir.

**Electric Submersible Pump (ESP)** is supplied with downhole pump, motor, series of impellers, separator. Electric power is obtained by motor via electric cable. Rotation of impellers dictation of production capacity of ESP

**Gas Lift** – static fluid level is below the surface. According to high bottomhole and low drawdown pressure, formation fluid can not reach to surface. Gas lift operating valve is like a door between annulus and tubing inside which allow gas to pump through itself into tubing to simply the density of the fluid [4].

### **1.2.Factors affect the selection of Artificial lift**

Some factors affect the selection of Artificial Lift methods. Some factors limits the use of some artificial lift types: Lets have a look to them:

- Nature of produced fluids: If fluid contain massive amount of solids(sand, wax, formation fines), rod pumps and ESP will not give better results.
- High Gas-liquid ratio will lower the efficiency of pump-assisted methods
- High viscous fluids will show complications in rod pumps
- Highly deviated wells may restrict the applications of the rod pumps
- Depletion drive reservoirs – Last stage production can give low volume capacity and may limit the application of gas lift method. Because injection of gas through operation valve requires high cost
- Water drive reservoirs – high water cut can limit the application of rod pumps
- Field location: offshore space may be limited that's why application of rod pumps is unavailable.

## **CHAPTER 2. Mechanism of Formation Damage**

Formation damage causes the formation permeability to go down in the wellbore region. Formation damage can occur due to multiple reasons which will be discussed later. The reduction in the permeability of wellbore region will affect in the reduction of productivity of the well. Pore throats in the near wellbore region are blocked. And this blockage caused the flow area to decrease. Another reason for reduced flow area is to have turbulent flow. When turbulent flow happens in the well, this causes much pressure drop in comparison with same flow. Pressure drop in the turbulent flow is higher than Darcy flow which result in reduction in the wellbore permeability [5].

## 2.1. Origins of Formation damage

Formation damage can occur from various reasons:

**During drilling** – As the drilling operation is going on the pay zone, filter cake is formed. Drilling fluid is a mixture of cuttings, water and weighting reagents. Particles forced into the formation. This is creation of formation damage, that's way carefully filtered drilling fluids should be chosen to minimize fluid loss.

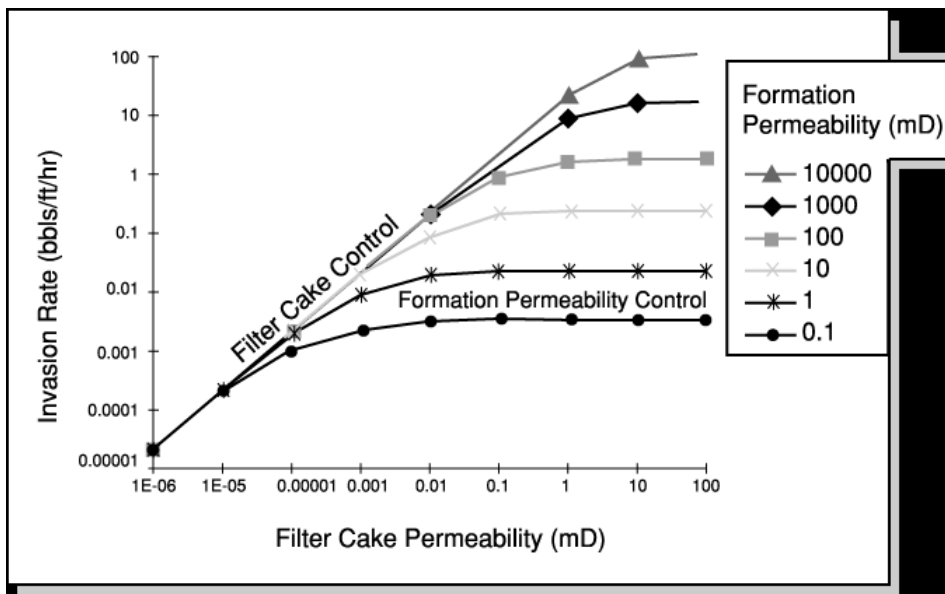

**Figure 3.**Dependence between filter cake permeability and rate of invasion [11].

How much pressure differential between borehole and formation are greater, invasion rate will increase in the case of increase in filter cake permeability.

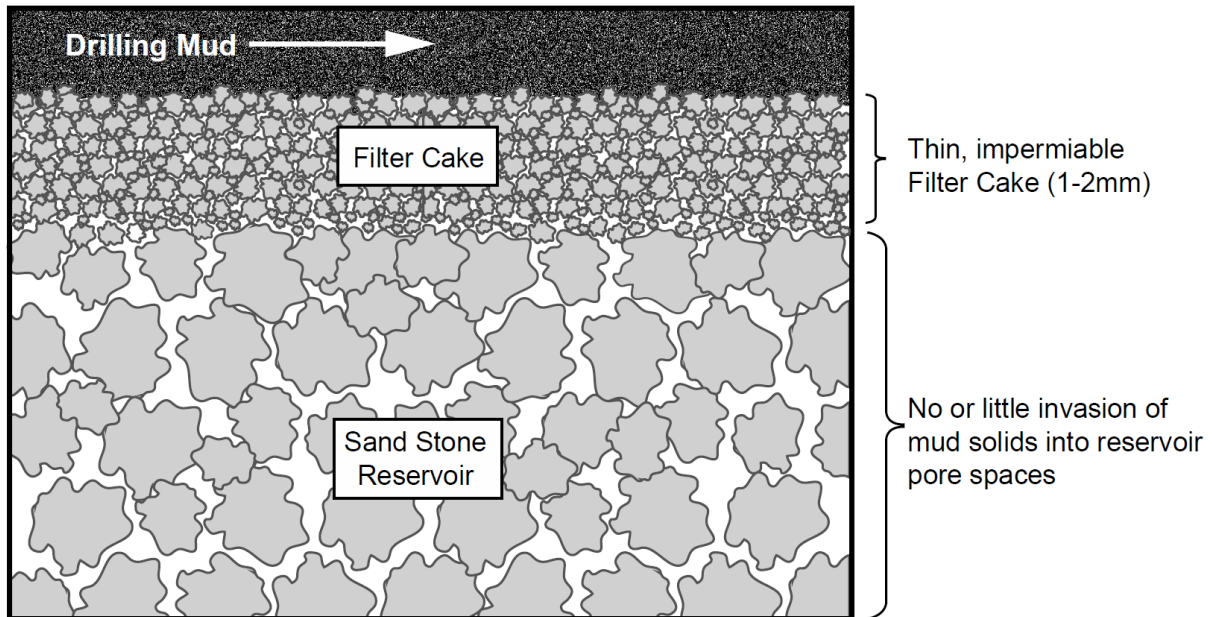
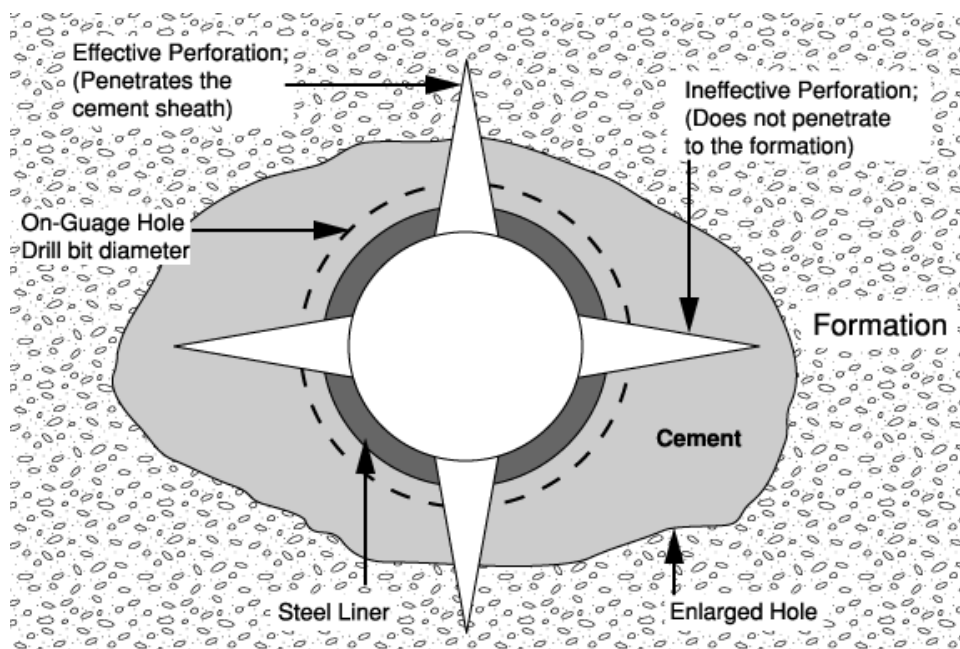

**Figure 4.** Effect of thin filter cake in less formation damage [11].

Thin filter cake is highly impermeable and desirable in cased hole. Thicker filter cake is less permeable and desirable in the open hole[6].

Clay swelling – clay swelling is one of the ever-occurring complications during drilling. It depends on the chemical properties of the formation. Clay swelling is the enlargement of the wall of the well. Differential sticking is major occurrence by the result of clay swelling. When the cations are hydrated during drilling, that zone of the well starts to enlarge. The formation which contain small clay minerals tends to react with injected fluid and clay swelling. It is mainly happened in water-based mud (WBM). Oil-based muds (OBM) are more preferable when clay formations are to be expected to drill. The other prevention method is to use clay stabilizer reagent [3].

**During completion** – When the cement slurry is injected into annulus, cement displaces mud out of the hole. According to differential pressure between cement slurry and formation causes the slurry to enter to the formation and to create the formation damage. When fluid loss from slurry occurs, dhydration of the cement makes the cementing operation fail, because slurry becomes to viscous. It prevents the cement slurry to rise to the given height before and remains inside casing. Failure of the cementing operation forms communication between layers [6].



**Figure 5.** Insufficient perforation due to overgauge hole [6]

Perforation efficiency is high to penetrate the cement sheath in vertical direction but this is not powerful to penetrate cement sheath in horizontal direction. Horizontal perforation can not bypass the damaged zone and productivity of this perforation will be reduced.

**During perforating** – Perforating process leads to have open perforations surrounded with reduced permeability zone. This zone contains perforation debris

and perforating rock cuttings. Reduced permeability zone makes the well inflow performance to decrease. For maximizing well productivity, perforation debris and remaining rocks should be cleaned. This operation is called clean-up. Clean up process involves the removal of perforation debris and reduced permeability zone. This process develops the transmissibility between formation and the wellbore. Clean-up process includes treatments like:

- Acidizing is utilized to dissolve the accumulated debris
- Backflowing under high differential pressure between formation and wellbore. High drawdown accelerates the production rate and leads to clean-up debris [3].

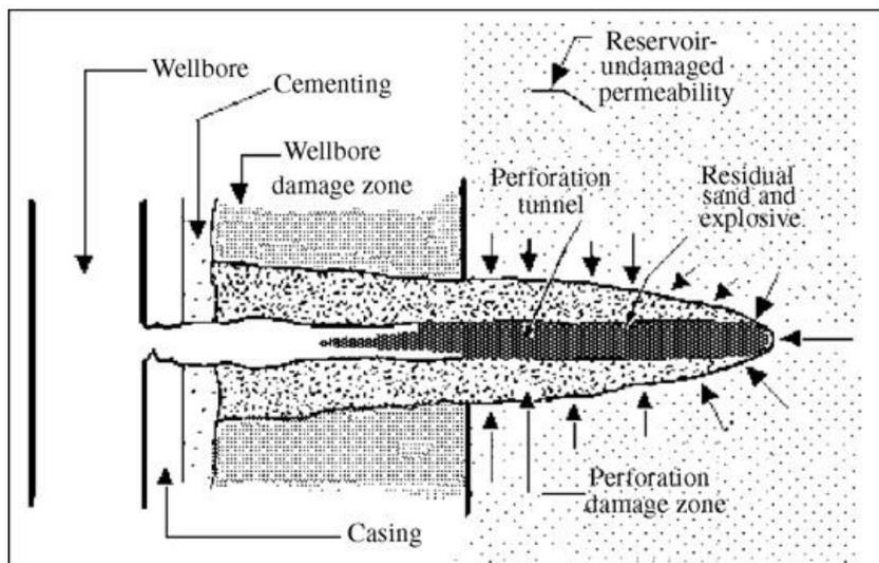

**Figure 6.** Formation damage formed during perforating [3].

**During production** – Production formation damage was created during production phase of the well. Various reasons for this are fines movement, incompatibility of workover fluids with formation, production scale or etc.

Fines production - Fine minerals are content of sandstone and carbonate rocks. Fine minerals stayed adhered to the pore throats. Van der Waals forces are large enough to hold these minerals adhered to pore throats at high salt concentrations. When the electrostatic forces are greater than Van der Waals forces, fines tend to



separate from minerals. They block the pores and forms formation damage by reducing wellbore permeability. When the fluid velocity is greater than a critical velocity can lead to remove the blocked pores. Polymers containing ammonium salts is used to cover the fines with polyvalent cations which can combine to mineral surface. Damage mechanism of fines migration is prevented when the electrostatic charges remained in balanced condition [8].

*Inorganic Scale* – Scale is the precipitation of the inorganic and organic mineral. During water injection process, scale can form when two water are incompatible with each other. While sea water contains the high concentration of the sulfate ions, formation water contains calcium, barium ions. Calcium sulfate, barium sulfate can precipitate in the tubing, bottomhole, perforations, in the accessories inside tubing.



**Figure 7.** Blockage inside tubing by scale precipitation [3]

Precipitation can block the perforations and reduce wellbore permeability. Scale inhibitor is used as prevention method to remove scale precipitation from damaged

zone. Scale inhibitor is injected into formation and dissolved the precipitation and retrieved with formation fluids [3].

Organic Scale – Some crude oils can lead to solid precipitation which is known as wax. When the temperature goes lower than cloud point temperature, wax (solid precipitation) reveals. When reservoir temperature is kept higher than cloud point, the solid phase is dissolved in the crude oil. To prevent this solid phase to form, scale inhibitor is used as mentioned before. As second precipitation method, heaters are used. By keeping the temperature higher comparing with cloud point, heaters are applied for this purpose during pipeline transportation, temperature fluctuations can become in different areas. Heating tankers can be used to keep the fluid temperature higher than cloud point [3].

Emulsion block - When the filtrate of direct emulsion (oil-in-water) drilling fluid takes in significant volume of emulsifier, an in-situ emulsification of interstitial oil becomes another possible reason of capillary impairment. This emulsification is possible because of the high rate of shear at the flow constriction, even though the bulk flow rate of the filtrate is low. If the stabilized emulsion is formed and droplet become trapped in the pores, it reduces the effective permeability. However, emulsifier will participate in the filtrate if excess volume is present in the emulsion mud. Therefore, in-situ emulsification can be avoided if care is taken in formulating and maintaining the emulsion muds [7].

Solid Invasion – this type of the formation damage occurs in whole types of the muds. Reason to occur is that hydrostatic pressure due to column of the mud in the well is not sufficient to hold the formation pressure balanced. Deposition of the particles contributes to the reduction in the wellbore permeability. Invasion depth and size of the damage can be controlled by selecting the optimum fluid design and correct

additives [9].

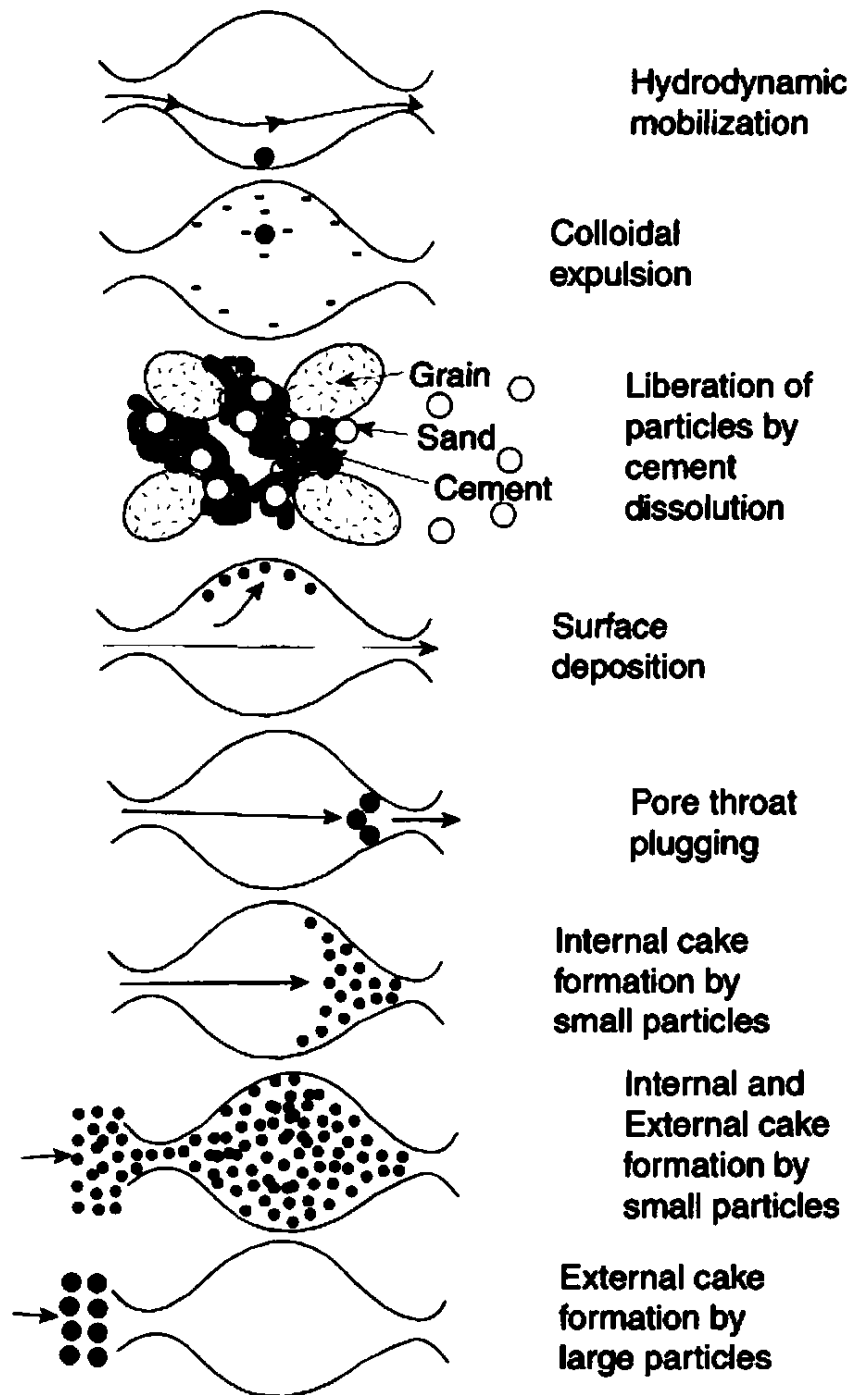
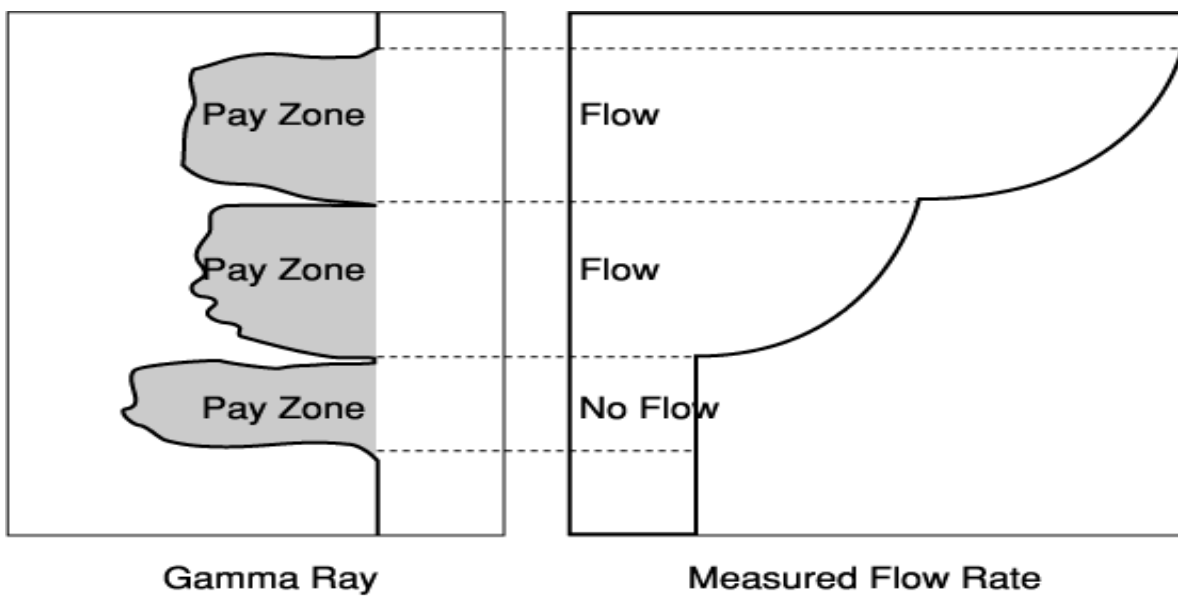

Figure 8. Solids entrapment into a pore system [10].

## 2.2. Determination of the formation damage

Production log is used to measure the production capacity and flow rate. This is one method to be aware of having formation damage. It is given information of the sand quality to be able to measure flow rate. From this graph, it is shown that upper and middle sands represent high flow rate. Being different from up and middle, bottom sand represent lower flow rate. Bottom sand can have formation damage and blocked pores. But of course, lower flow rate can not indicate formation damage, this can indicate that, this can be depleted formation and depleted reservoir pressure.



**Figure 9.** Log determine the zone having formation damage [3].

Type and location of formation damage should be known before to make an attempt to remove formation damage. Formation damage determination is implemented like:

- following the services during well life to determine the origin of formation damage or naturally depleted formation
- making the laboratory test or core flushing to determine the type for formation damage [3].

### 2.3. Evaluation of the Skin factor

The Skin measures the severity of the formation damage. Formation damage reduce permeability around the wellbore. Figure 9 represents ideal pressure profile of the well. This graph shows that how formation damage skin affects to create additional pressure drop. Yellow line shows the pressure profile of the damaged well [3].

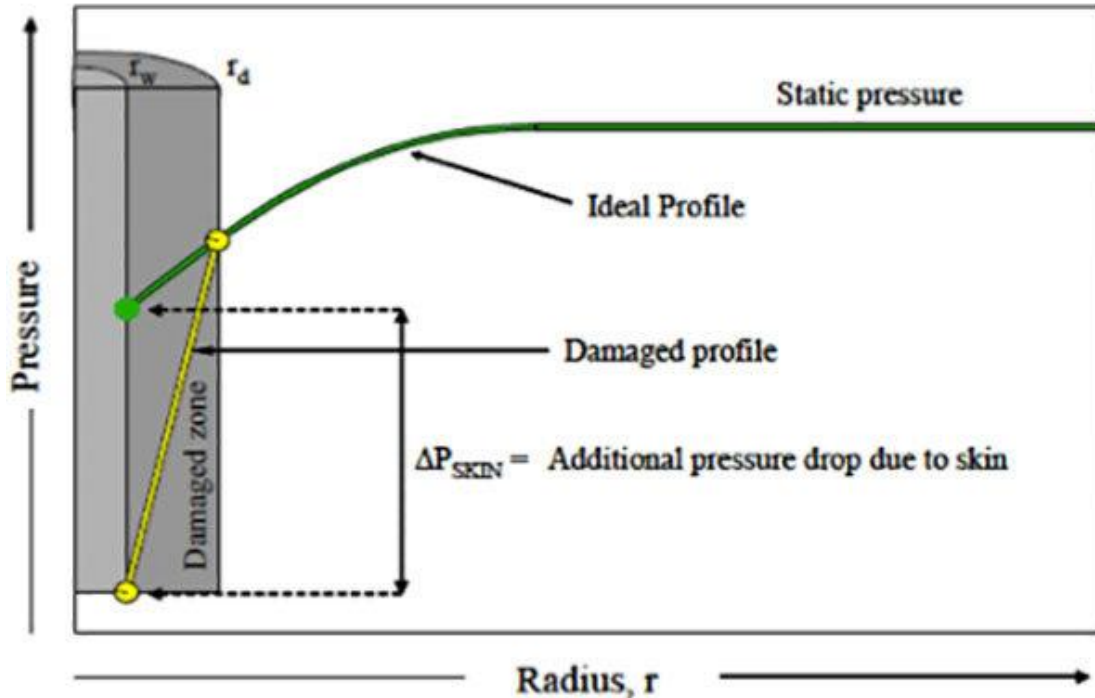

**Figure 10.** Effect of the skin on pressure profile [3].

$$S_d = \frac{2\pi k_0 h \Delta P_d}{q_0 \mu_0} = \left( \frac{k_0}{k_d} - 1 \right) \ln \left( \frac{r_d}{r_w} \right) [3].$$

$h$  - formation height

$q_0$  - oil flow rate

$\mu_0$  - oil viscosity

$S_d$  - formation damage skin

$k_0$  - formation permeability to oil

$k_d$  - damaged permability to oil

$\Delta P_d$  - extra pressure drop due to formation damage

Formation damage skin depends on the ratio of original permeability to the damaged permeability. If this ratio increases, skin increases as well.

## **CHAPTER 3. Matrix Acidizing**

When the fluid production rate is decreased, having of the formation damage is suspected. After looking for the precise reason for the damage, diagnosis is put for the damaged well. Well stimulation methods come to help to remove the damage. Well stimulation methods is used for:

- Increase production rate
- Increase reservoir economical life
- Removing extra pressure drop
- Remove the formation damage which causes additional pressure drop
- Delaying the onset of water and gas production

Matrix acidizing process involves injection small quantities of the acid at pressure less than fracture can be opened. Small quantities of the acid went through the perforations and wellbore. This mixture helps to dissolve the part of formation rock and plugged pores. By dissolving the plugged pores, flow paths are widened and production rate maximized due to the permeability of the wellbore rock is increased. Acid wash is like acidizing fluid but it is injected to widen perforations. Perforations can be captured by debris during perforating and also they can be caught by scale or in the tubing accessories [11].

### **3.1. To prepare the well before acidizing**

Prior to starting matrix acidizing process, well should be cleaned. Before injecting the acid into formation, well and all tubing accessories should be washed. If these accessories doesn't wash, the solids which are content of the acid, they will be deposited inside the tubing and the perforations and contribute additional formation damage. Acid is injected through tubing and near bottom to clean out all deposited solids and particles and then came back into the stock tank. After ensuring that the well has been cleaned, acidizing treatment can be commenced [11]

### 3.2. Acid treatment design

After observing the reduction in the productivity compared in other wells, it is an indicator of having formation damage. Now you have to design the treatment.

- evaluate the safe injection rate, determine borehole fracturing gradient. Injection pressure should be 200 psi lower than fracturing gradient.
- evaluate the safe injection rate into undamaged zone and damaged zone separately
- choose the stages for fluid compatibility. Conduct the fluid-fluid compatibility test to make sure that all fluids which have chosen for treatment are compatible.
- measure the volume of the acid required for treatment for crude oil displacement, formation brine displacement, hydrochloric or hydrofluoric acid in the case of without precipitation and overflush stage [12]

Stage Number	Stage Name	Reason for Stage	Information Source	Stage Composition	Stage Volumes*	
I	Crude-oil displacement	Prevent oil sludging by acid	Acid/crude oil sludging test	Aromatic solvent (xylene, toluene)	Radial displacement: 3 ft (Fig. 7.3)	
II	Formation water displacement	Prevent scale deposition HCO <sub>3</sub> , SO <sub>4</sub> content	Formation water analysis	Sandstone: 3% NH <sub>4</sub> Cl; carbonate: 2% KCl and 3% NaCl	Radial displacement: 3 ft (Fig. 7.3)	
III	Acetic acid stage	Iron compounds in formation pyrite, siderite, hematite, chlorite clay	X-ray analysis	10% acetic acid	%CaCO <sub>3</sub>	gal/ft
					0–5	25
					5–10	50
					10–15	75
					15–20	100
IV	Hydrochloric acid	CaCO <sub>3</sub> or other HCl soluble minerals	X-ray analysis or HCl acid solubility test	According to core mineralogy 3 to 15% HCl	Sandstone:	
					% HCl soluble	% of HF stage volume
					< 5	50
					5–10	100
					10–20	200
					Limestone:	
					25–100 gal/ft	
V	Hydrofluoric acid (not used on carbonates and sandstones when HCl solubility > 20%)	Clay damage	X-ray analysis, SEM analysis	According to formation mineralogy 0.5 to 3% HF and 3 to 13.5% HCl	75 to 150 gal ft	
VI	Overflush	To spend acid/to flush spent acid from perms	Always use	(a) 3% NH <sub>4</sub> Cl (all wells), (b) nitrogen (gas wells), (c) diesel oil (oil wells), (d) 5% HCl (water wells)	Same volume as HF acid or volume to displace to 5 ft radially	

\*Minimum stage volumes: 500 gal.

**Table 1.** Acidizing stages [12]



### 3.3. Acid selection carbonate reservoirs

*Hydrochloric* is acid used in the matrix treatments to dissolve carbonate minerals. It help to dissolve the chlorite. This acid has the highest corrosivity to the metal steel. Corrosion inhibitor is used to prevent the corrosion occurrence. Reaction is like:



*Acetic acid* is used in the matrix acidizing treatments when the slow reaction rate is required than reaction rate of hydrochloric. This acid has no corrosivity than HCl



*Mud Acid* is not recommended to apply in the carbonate reservoir. This acid is prepared by the blend of HCl and HF. This acid dissolves the quartz, clay micas minerals. HF is not recommended to use in the carbonate reservoirs as treatment fluid which cause the precipitation with calcium cations.

Some other types of the acid can be used for the same reason depending on the type of formation damage and reservoir condition. Due to this graph was created by MC Leod, firstly, Hydrogen chloric acid used in carbonate reservoirs to dissolve the carbonate minerals which captured the pore spaces. Removal of the carbonate minerals helps HF not to react with these minerals. HCl dissolves the carbonate in the wellbore which act as a barrier between sodium or potassium with HF. The disadvantage of HCl is high corrosivity. HCl-HF mixture is the best choice in sandstone reservoirs. HF is a dilute solution in HCl. Often 15% HCl is used with the mixture of  $\text{NH}_4\text{F}_2$  to form 3% HF. 12% HCl remains in the solution after consumption of hydrogen chloric. Similarly, 6% HF is generated from 15% HCl and final HCl concentration is about 9% [14].

*Carbonate Acidizing:*

Perforating fluid	5% acetic acid
Damaged perforations	(a) 9% formic acid (b) 10% acetic acid (c) 15% HCl
Deep wellbore damage	(a) 15% HCl (b) 28% HCl (c) Emulsified HCl

*Sandstone Acidizing:*

HCl solubility > 20%	Use HCl only
High permeability (100 mD plus)	
High quartz (80%), low clay (< 5%)	10% HCl-3% HF <sup>a</sup>
High feldspar (>20%)	13.5% HCl-1.5 HF <sup>a</sup>
High clay (>10%)	6.5% HCl-1% HF <sup>b</sup>
High iron chlorite clay	3% HCl-0.5% HF <sup>b</sup>
Low permeability (10 mD or less)	
Low clay (<5%)	6% HCl-1.5% HF <sup>c</sup>
High chlorite	3% HCl-0.5% HF <sup>d</sup>

<sup>a</sup> Preflush with 15% HCl

<sup>b</sup> Preflush with sequestered 5% HCl

<sup>c</sup> Preflush with 7.5% HCl or 10% acetic acid

<sup>d</sup> Preflush with 5% acetic acid

**Table 2.** Description of Acid Treatment [14]

### 3.4. Matrix acidizing in the sandstone reservoirs

Matrix acidizing design in carbonates is different from acidizing in the sandstones. In the sandstones, acidizing design involves the injection of three fluids: preflush, mixture of the hydrogen fluoride and hydrogen chloride, afterflush.

Preflush acid is first injected into near wellbore region to dislodge connate water. HCl in the preflush changes around 5-15%. Preflush prevents the interaction of the sodium and potassium ions in brine with HF. This helps not to precipitate sodium and potassium with HF and having new damaging point. HCl itself reacts with carbonate minerals and keeps the expensive HF reacting with carbonate and precipitation of the  $\text{CaF}_2$ . After first phase. Mixture of HF and HCl is injected into damaged zone. And reaction between HF and sands, drilling mud, cement is being going. HCl keeps pH low and prevents the precipitation HF with brine. In the last stage, afterflush is injected into formation to retrieve the acid to the surface, to restore

the wettability of the rock, to clean the acid treatment precipitations. Afterflush helps to remove the precipitated minerals after the acid treatment. In some hot reservoirs precipitation is rapid, afterflush is not beneficial. Afterflush should be carried up immediately after acid job without delaying. Afterflush can be nitrogen, oil, diesel and ammonium chloride [14].

### 3.5. Analysis of the Acid Response Curve

The core is taken from the reservoir and placed on laboratory to conduct the test. This test studied by Smith and Hendrickson helps to determine acid response by watching wellbore permeability and the volume of the acid. The core is acidized and the mixture of HF and HCl is injected into the wellbore. As certain time passed, it was observed that in the initial phase of injection, permeability decreased and again started to increase. Permeability decreased in the initial injection because that rock matrix was broken down and fines moved downward. This disintegration of the rock blocked the flow channels. Then mixture of the HF and HCl affects to damaged area and dissolves the rock and permeability starts to increase again. One of other reason in permeability reduction is the separation  $CO_2$  from the reaction carbonate rock with mixture of HCl and HCl [12]

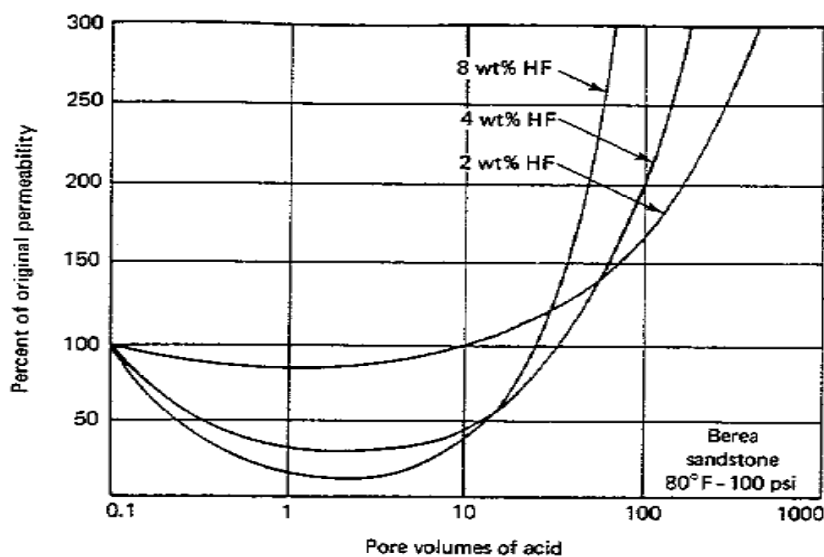

**Figure 11.** Acid response curve [12]

### 3.6. Selection of the injection rate and acid volume

Acid injection rate during matrix treatment should be implemented at a rate lower than fracture initiation. The allowable injection rate is measured like:

$$i_{max} = \frac{141.2 * 10^6 k_{av} h (P_{fpp} - \Delta P_s - P_r)}{\mu (\ln \frac{r_f}{r_w}) + S} \quad [12]$$

$i_{max}$  = maximum injection rate (bpm),

h = net treated height (ft),

$\mu$  = viscosity of injected fluid (cP),

$P_r$  = reservoir pressure (psi),

$r_w$  = wellbore radius (ft),

$k_{av}$  = (average) undamaged permeability (mD),

$P_{fpp}$  = fracture propagation pressure (psi),

$\Delta P_s$  = safety margin (e.g. 300 psi),

$r_f$  = radius of injected fluid (ft),

S = skin factor.

Volume of the acid required for treatment calculated like:

$$V_p = 7.48\pi (r_a^2 - r_u^2) h \phi \quad [12]$$

$V_p$  – Volume in US gallons,

Formation Temperature	<150 <sup>0</sup> F	150 <sup>0</sup> F-200 <sup>0</sup> F	>200 <sup>0</sup> F
Permeability	Volume of the Mud Acid(ga/ft)		
<20mD	100	50	50
20-100mD	150	100	100
>100mD	200	150	100

Table 3. Volume of Acid depending on the permeability and temperature [12]

When the permeability of the wellbore increases, volume of the acid pumped will increase as the temperature decreases.

Before starting the acidizing process, laboratory tests are conducted on the core to determine what type of acid is used or on which temperature etc.

Mineralogy test of the formation was analysed to determine the porosity and permeability of the formation

Fluid-Fluid suitability test of the formation helps to determine that all fluids which have chosen for treatment fluids are compatible with each other and don't contribute to the precipitation which redamages the wellbore and create pressure. [3]

### **3.7. Ranges of the additives used in the treatment fluid**

Some additives play an important role to carry out many purposes in the matrix acidizing treatment. The cost of the treatment fluid is so expensive. Some types of the additives are not suitable with each other. Acid has strong corrosivity for the steel of tubing and casing. There are other additives iron controlling agents, surfactant but the most important acid is corrosion inhibitor. All other additives should be used depending on well and the formation condition and its mineralogy. But corrosion inhibitor is always used in the treatment fluid without depending on the any condition in the well. Corrosion rate increases as a function of temperature.

Corrosion inhibitor – This acid is used in the treatment fluid to reduce the corrosion rate. When the spent acid retrieved to the surface, This went through the tubing and other accessories. As being contact with tubing steel, this steel undergoes the corrosion. The preventing acid has depleted by the reaction of the acid with the rock surface. Injection of the inhibitor to the formation occurs in this time. Corrosion inhibitor doesn't shield the pipe surface, it only absorbs onto the steel and delays the occurrence of corrosion.

Mutual solvent – As the corrosion inhibitor is injected into formation, it is absorbed onto rock surface and changes the wettability of the rock (oil wet prefers). Adsorption changes the wettability of the rock. Acid-insoluble remains plug the pore spaces. Mutual solvents is injected into formation to prevent the adsorption the of the inhibitor to the rock surface. This controlling agent increase the solubility of the adsorption of the inhibitor and acid-insoluble minerals. Ketones, ethers, alcohols can be known as the mutual solvents

Nitrogen – is injected into the formation to retrieve the spend acid easily[15]

## CHAPTER 4. Hydraulic Fracturing

In this method, mixture of the treatment fluid with additives is pumped into the formation. Local stresses exceeds the tensile stresses in the wellbore and makes the injection fluid deeper into the formation. Fracture propagates in the formation. The mixture which contains the water, chemicals and sand-formed proppant is pumped into the formation to hold the fracture open and allow formation fluid to flow into the well. Proppant filled fractures are high conductivity channels. Shale or tight gas contained in the shale or tight sand are considered to be unconventional sources. Hydraulic fracturing is the best method. Some elements should be evaluated before starting acidizing treatment.

-the severity of the formation damage

-formation flow capacity

-length of the wellbore damage

-economic life of the well after returning the well back to production

-sufficient volume of the hydrocarbons in the formation

Volume of the treatment fluid injected into formation depends on the production capacity of the formation. If this capacity is greater, little volume of the fluid is enough to remove this damage, but capacity is low, high volume of the treatment fluid should be injected to pierce the wellbore deeply [16].

Well inflow can be measured by below equation which increased by hydraulic fracturing:

$$Q = \frac{2\pi kh(P_r - P_{wbr})}{\mu_0 B_0 \left( \ln\left(\frac{r_e}{r_{wbr}}\right) - \frac{3}{4} \right)} [3]$$

$B_0$  – oil formation volume factor,

$\mu_0$  – viscosity of the formation fluid,  $r_e$  – drainage radius,

$r_{bth}$  - wellbore radius,  $h$  – height of the production zone,

$P_r$  – reservoir pressure,  $P_{wbr}$  – wellbore pressure

#### 4.1. Fracturing Pressure

In hydraulic fracturing, fractures created by pumping fluid will be horizontal or vertical. This issue is the point of interest for service company. If fracturing process is carried out in deeper sections (deeper than 600m), fractures tend to be vertical. Three pressure are classified here. More pressure is applied to break down the formation than pressure to propagate the fracture.

Breakdown pressure: is a pressure which is used to disintegrate the formation and initiates the fracture

Propagation pressure: is a pressure contributes to expand the fracture

Shut-in Pressure: Distinguishing from previous two pressure, this is applied to keep the fracture open.

Shut-in pressure depends on the fracture width. Fracture width comes from how much injection fluid is injected during fracturing. Greater volume of the injection fluid, higher shut-in pressure is [6].

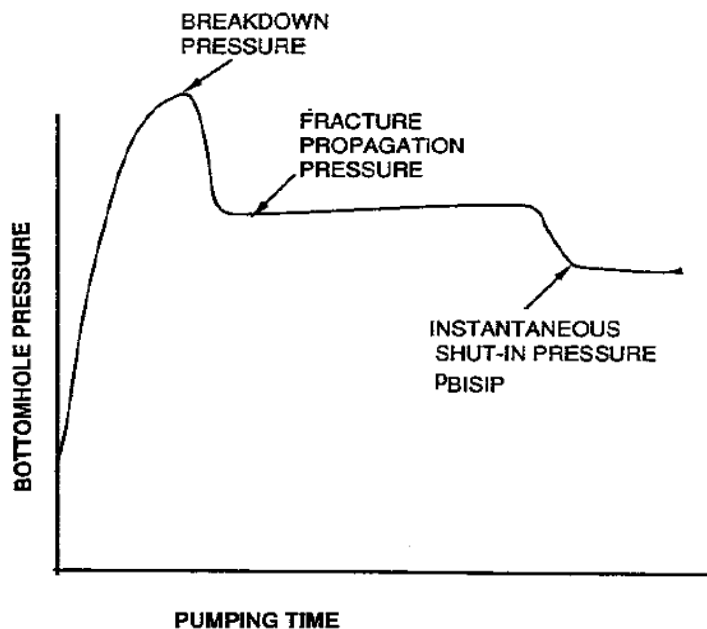
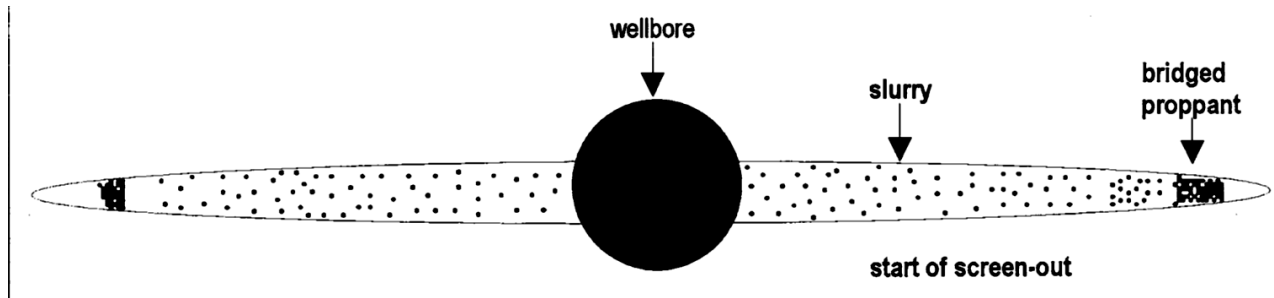



**Figure 12.** Pressure behavior in fracturing [6].

#### **4.2. Description of the tip screen-out screen**

This method is used when high fracture flow conductivity is need. Fracture width is increased due to proppant-filled slurry. Increase in the fracture width gives high fracture. conductivity.



**Figure 13.** Tip Screen-out technique [17]

This mechanism includes the injection of the treatment slurry into the formation. It propagates the fracture to desired length. Dehydration occurs due to absorption of the fluid the content of the slurry and filter cake around the fracture forms as a layer. Dehydration of the slurry results in the proppants bridging in the dip of the fracture and stopping the propagation. Next amount of the treatment fluid is injected into formation and cause wellbore pressure to increase and increase in the fracture width. Wider fractures requires greater concentration of the proppants [17].

#### **4.3. Stress state for the mechanism of hydraulic fracturing**

Correct analysis and the understanding of the fracture network can give us sufficient recovery factor after acidizing process. Right understanding of the stress state, it can result in the optimization the production of the well. Stress anisotropy should be evaluated for the better performance of the well after hydraulic fracturing. Taking into account that , tight reservoirs which are the best candidate for the hydraulic fracturing, this method is applied to create high conductivity channels. It is necessary to analyse

of the new fractures with naturally fractured channels, their orientation.

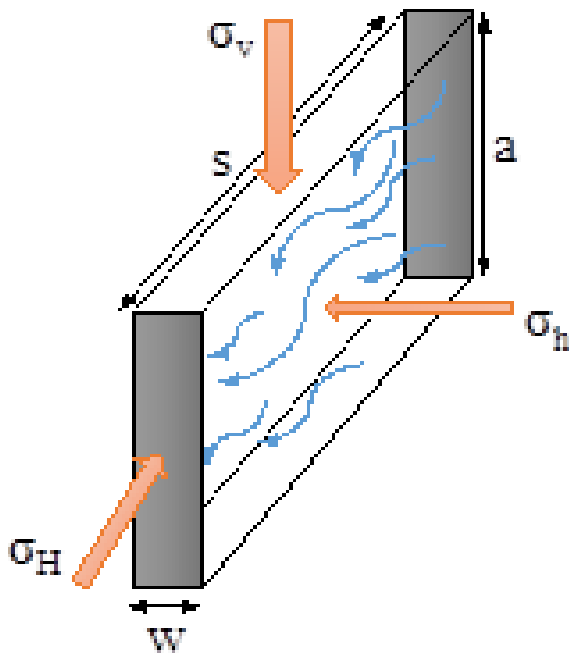

**Figure 14.** Stress anisotropy around the borehole [16]

In-situ stress is split into 3 types. Vertical ( overburden) and two horizontal stresses. Fractures happens at least to minimum principal stress. Vertical stress is called overburden stress. Overburden stress generated due to weight of the overlying rocks. Horizontal stresses come from the breakdown of the rock and tectonic forces. Minimum horizontal stress is perpendicular to the overburden stress. Maximum horizontal stress can be generated by the interaction of the breakdown pressure and rock's tensile strength postulated by Haimson and Fairhurst. Formation pressure, weight of the overlying rocks, tectonic forces can cause the changes in the principal stresses. These three principal stresses determines the fracture azimuth, fracture width, height, length.

Overburden stress can be measured by the density log. These in-situ stress can be estimated by the Poisson's ratio [16]

$$V = \frac{-\varepsilon_y}{\varepsilon_x} = \frac{-Lateral\ Strain}{Longitudinal\ Strain} \quad [16]$$

#### 4.4. Fracture Geometry

Optimization of the fracture geometry result in the maximization/enhancement of the productivity of the well through the fractures. Single or multiple fractures, their geometries, azimuth, height, width of fractures can be questionable or unknown for determining the well's performance. Optimum fracture design (OFD) should be implemented by various mathematical, numerical models such 2D or 3D models (The Khristianovic-Geertsma-de Klerk (KGD), Perkins-Kern Nordgren (PKN), radial model) [16]

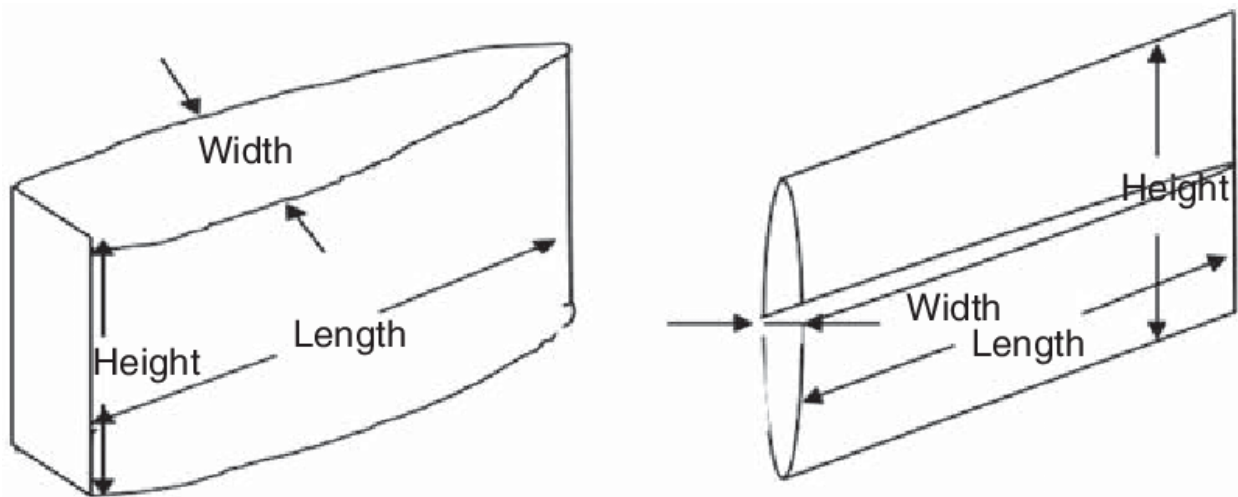
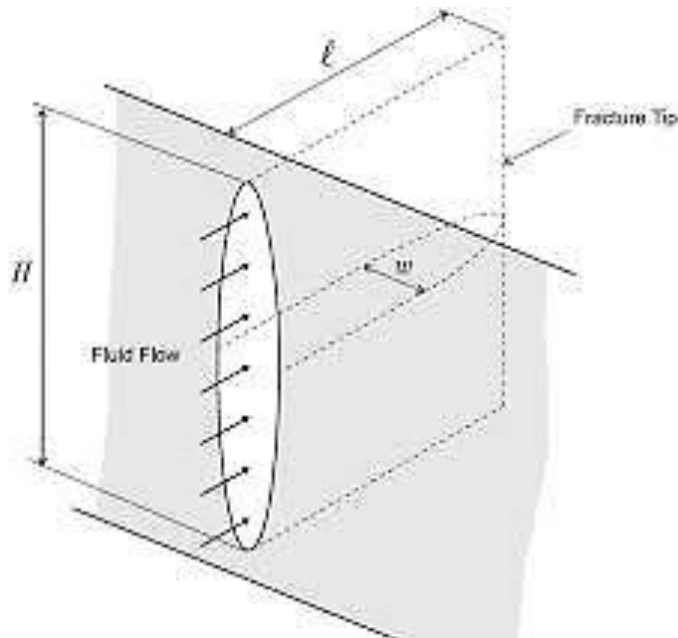

**Figure 15.** Description of the fracture geometry [16]

#### 4.5. 2D - Perkins-Kern Nordgren (PKN)

Fractures design requires the knowledge of the fracture geometry. Design of the fractures should mostly be done by 2D models. Fractures height is accepted as constant in this model but fracture width and length changes by he means of the

fracture height.



**Figure 16.** View of the PKN model [18]

Fracture length is greater than fracture width and height. In the PKN model the fracture planes are considered to be perpendicular with vertical plane. In this model the fracture cross section is in the elliptic form and it is supposed that the fracture geometry doesn't depend on the fracture toughness. The PKN model is most applicable when the the fracture length is considered to be less than fracture height. This model guess that fracture toughness is ignored because energy allowed the flow to flow through the cracks is higher than that to scatter. Without taking under consideration of leakoff, the length of the fracture using PKN model is calculated by: [18]

$$L_f = C_1 \left[ \frac{Gq_0^3}{(1-\nu)\mu h_f^4} \right]^{1/5} t^{4/5} \quad [18]$$

Where,

$\nu$ - Poisson's ratio,

$C_1=0.45$ ,

G-shear modulus, KPa

$\mu$  – viscosity of pumping fluid, cP

$h_f$  – height of the fracture

$q_0$  – flow rate,  $m^3/ \text{min}$

By utilizing plain strain possibility, the problem which fracture length being higher than height is diminished to two-dimensionless analysis. Plain strain analysis comes to conclusion that elastic breakdowns of the rock are focused on the vertical planes perpendicular to fracture propagation.

#### **4.6. The Khristianovic-Geertsma-de Klerk(KGD) model**

This model which is used to aim for design fracture geometry is one of the 2D models. This model is applied to design fracture geometry when fracture height is much higher than fracture length. Rather than to measure exact values for fracture sizes, main goal is to apply these models to come to conclusion. If the accurate value of the fracture height is chosen to model the fracture geometry, this model will provide the exact evaluation of the fracture length and width. Formation is accepted as unlimited, homogeneous, linear elastic matter defined by Young's modulus and Poisson's ratio. Fracture fluid is considered Newtonian and its viscosity is marked with  $\mu$ . Its injection is carried out under constant flow rate Q, flow is laminar. Gravitational effects are not deal in this model. [18]

$$W = 2.52 \left[ \frac{(1-\nu)Q\mu L}{G} \right]^{1/4} \quad [18]$$

$\nu$ - Poisson's ratio,

G-shear modulus, KPa

$\mu$  – viscosity of pumping fluid, cP

$w$  – width of the fracture

$Q$  – flow rate,  $m^3/\text{min}$

As fluid injection rate being in straight dependence with fracture width, greater fluid injection rate, wider fractures are.

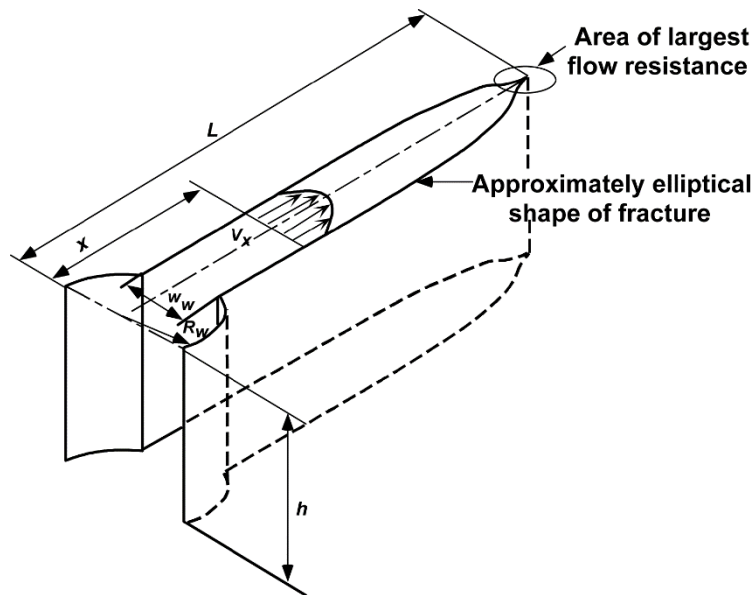
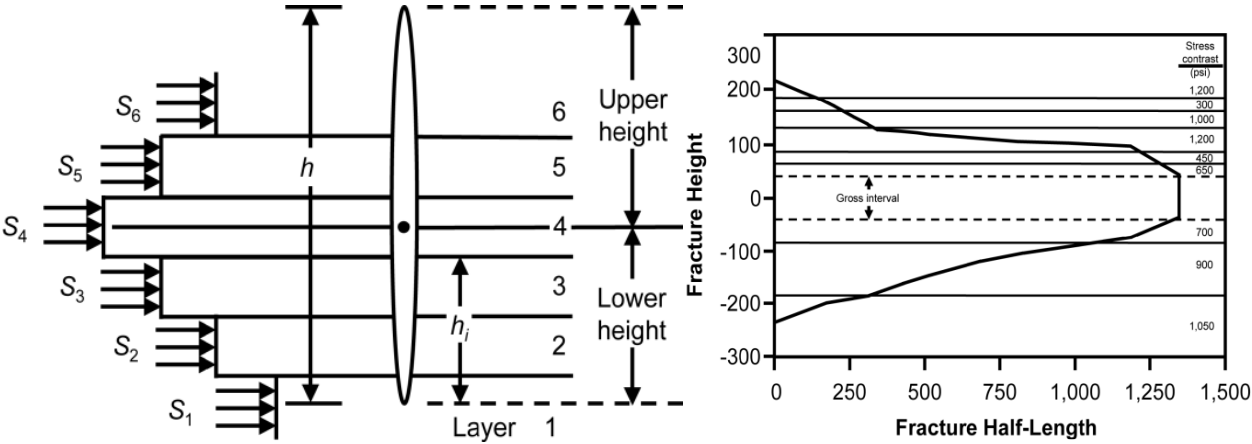

**Figure 17.** View of KGD model [18]

#### 4.7. 3D fracture design models

2D models are applied for the purposes which is basis for to design fracture propagations. Now technology owns ever-improving computers which enable the engineers to utilize pseudo three dimensional models (P3D). P3D models have a bunch of the advantages which create inevitable chances to calculate fracture height, width, length together and whole layers upward and downward than perforated zone. In P3D model, fracture initiation starts with lower in-situ stress. Stress strain of bounding layers and other mechanical characteristics identifies the height growth. Growth into the other sand layers depends on the stress and thickness of inter bedded

shale layer and the distance between the two; it is independent of the wellbore and perforations in the layer [18].



**Figure 18.** Width and height combination in P3D model (L) Length and height connection in P3D model [18].

**4.8. Fracture Height**

Fracture height is tough enough to predict in the design of the hydraulic fracturing treatment (HFT). For measuring the fracture height, the thickness of the subsurface layers should be known. For this purpose, 3D propagation models come to help to get information about it. Preferred way to evaluate the fracture height is to commence at perforated interval and continue up to the layers which contain shale and denser rocks act as a barrier to fracture growth. Some factors control the fracture. Viscosity of fracturing fluid, injection rate should be taking into consideration prior to starting hydraulic fracturing treatment. Let's analyse the fracture height from the log:

- a- Fracture is started from the top of pay zone and doesn't surround the intact perforated interval which is not preferred.

- b- Fractures surround the nonperforated area which leads to the reduction in the fracturing fluid volume
- c- Fractures propagated into downward of the perforated zone and oil-water contact (OWC) which cause unacceptable water production and water coning problems [19].

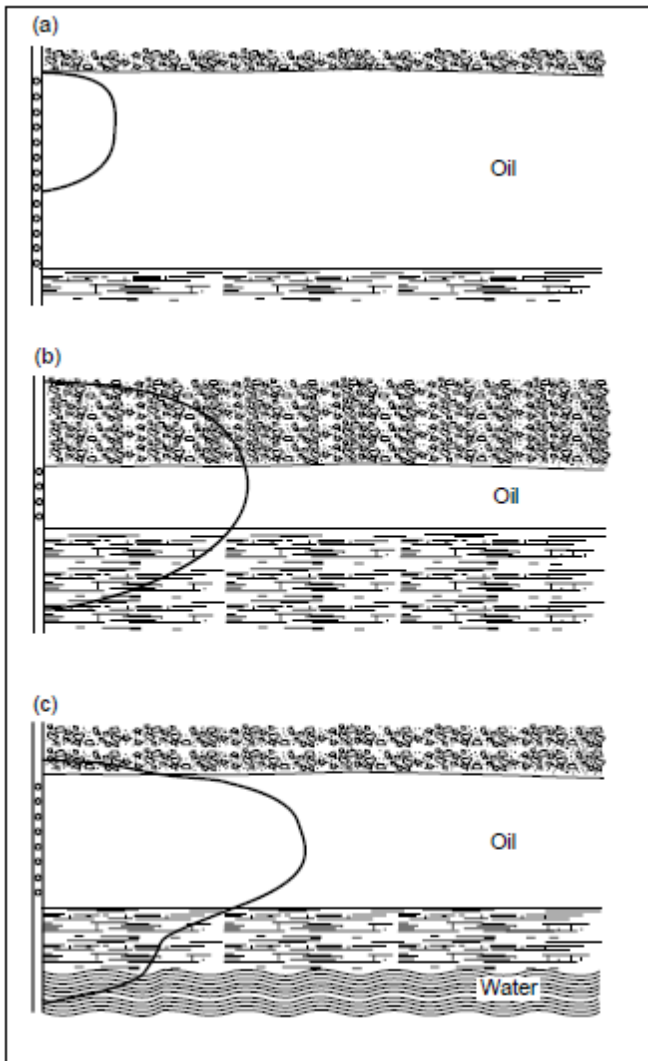

**Figure 19.** Necessity of the fracture height [19]

#### **4.9. Selection of design of the hydraulic fracturing treatment**

The factors which must be taking into consideration the net present value (NPV) prior



to starting fracture treatment design are:

- Selection of the fracturing fluid
- Selection of the proppant
- Injection pressure of the fracturing fluid
- Choosing the fracture propagation model
- Volume of the pad
- Formation permeability
- Production forecast (Well test) [16]

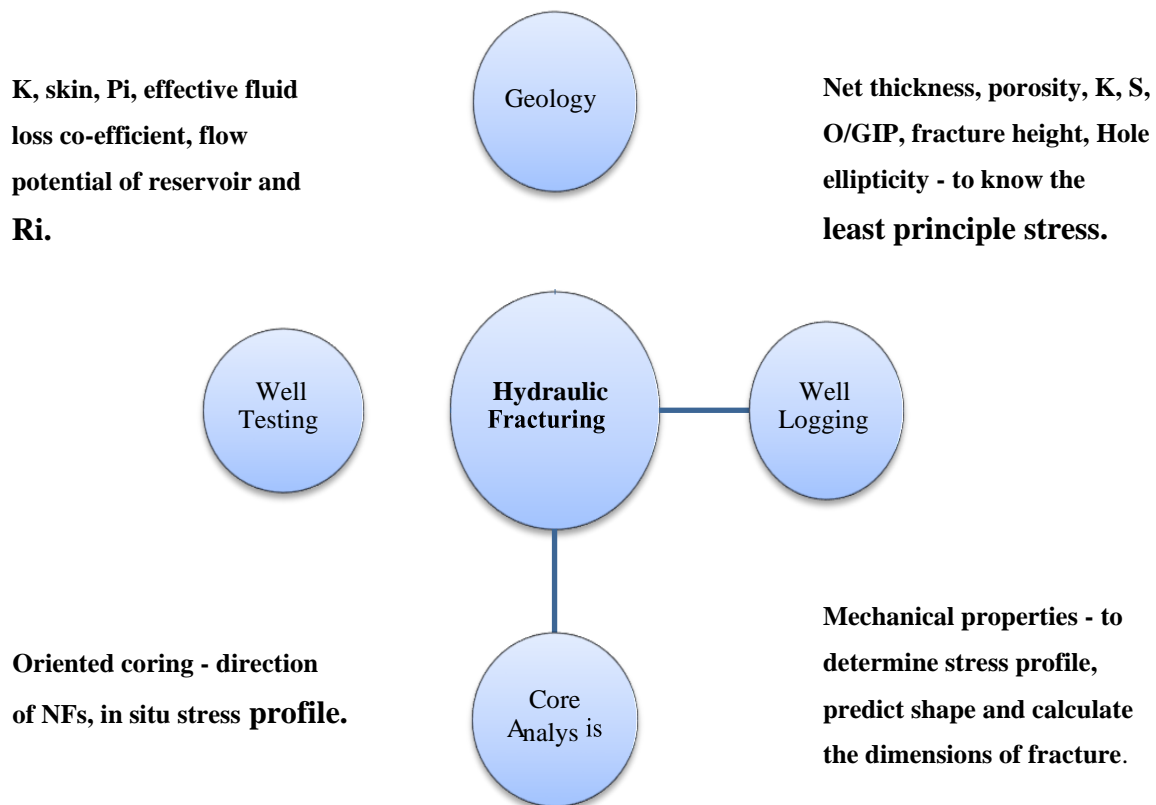

- Net present value analysis

**Figure 20.** Major sources of data [16]

The fracturing design engineer desires to design the optimum fracturing geometry. Optimization of in-situ stress profile supplies the maximum productivity/injectivity of a hydraulically fractured well (HFW) with a fixed fracture volume. Correct approach to in-situ stress acting around the wellbore enables as to determine fracture geometry. Proppant selection is very important and its size is based on the stress distribution and fracture height. Formation permeability is primary factor in applying the hydraulic fracturing treatment. According to different types of the formation damage, permeability around the wellbore reduces to a level which causes to decrease in production of the oil and gas. For determining the fracture geometry, 2D and 3D models are applied. 2D model doesn't simulate real-life conditions. Best solution is to apply 3D design models which helps to analyses fracture geometry by looking fracture width, length and height together. After hydraulic fracturing, well test analysis is carried out to measure production capability of the well. [16]

#### **4.10. Types of proppants and the hydraulic fracturing additives**

In fracturing method, high pressure fluid is injected into the wellbore to create channels. While treatment is finished, cracks closes and treatment fluid disappears through the wall of the crack. This moment is the best moment to injecting propping material. When fracture is accepted as wide and long, proppant is injected into these fractures. Proppant is uniformly sized particles. These proppants contribute to keep the cracks open while production. Two types of the proppant are classified:

- high viscosity proppants

- high rate proppants

High viscosity transporting proppants are used in the treatment fluid to generate large diameter fractures. High rate proppants are used to generate the micro fractures.

Types of the proppants which are content in the fracturing fluids are classified into three groups in industry:

- Frac sand proppant (FS)
- Resin coated proppant (RCS)
- Ceramic proppant (CP)

Sand content which is comprised of high purity, sand is known as frac sand. Shale reservoir or reservoir contains tight sand requires to be best solution for hydraulic fracturing treatments. Because these type of reservoirs have lower permeability and oil and gas doesn't flow into the well freely. Due to its power, it is crush resistant and this is beneficial as propping open fractures made after sand processing facilities. Frac sand has lower conductivity than other proppant types[20]

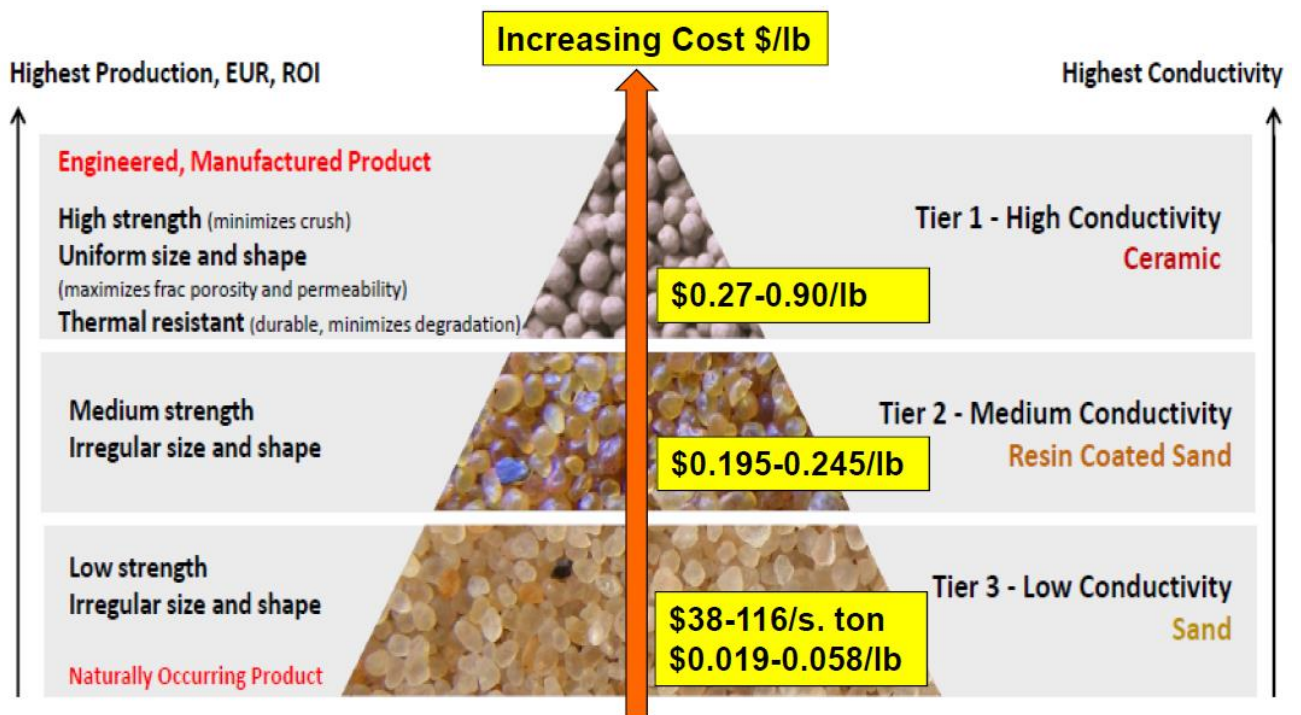

**Figure 21.** Proppant types and their characterization [20]

Size of the proppants range from 0.1mm to the 2mm depending on customer reservation. The advantage of the frac sand as proppant is to be transported without turbulence. It has endurance to breakdown forces from closing of the cracks.

Sand which is used as proppant should be processed. It can't use after

taking directly from the ground. Sand is dispatched to the processing plant and washed to clean the fine grains from it. Sand is put on the piles to permit the water to drain. When the drain operation ends up, under the open weather the sand is dried by the air to sweep the moisture away. As the last stage of this operation, the dry sand is meshed to collect the specific sized of the grains.

Resin coated sand (RCS) have been used as proppant in the fracturing fluid as for various purposes. RCS is used to prevent the proppant flowback while in maintaining high sand concentration of fracture fluid. RCS is added to fracture fluid as the 10-20% of frac sand. RCS has higher compressive strength helping to prevent proppant breakdown. These resins creates consolidated and strong pack with sand to prevent the flowback of them.

Frac sand and RCS are not beneficial in some reservoirs. According to high-grade sand, ceramic proppants are applicable in this reservoirs. Let's get to know with advantages of ceramic proppants:

greater breakdown strength – when the well goes to deeper, pressure and the stress on the proppants rises. That's why frac sand is not good choice of the proppants. This type of proppants can endure to greater breakdown power (pressure till to 10000psi)

higher conductivity – ceramic proppants can result in the higher conductivity than it is created by the frac sand and RCS. Due to higher conductivity, oil and gas from the formation flow easily into the well. The another advantage is the thermal and chemical property of the ceramic which prevents to have reactions with the shale formation and the its deposits to form and redamage the wellbore. [20]

## CHAPTER 5. Research Methodology

For increasing the drainage area of the well, horizontal wells are effective than vertical wells because the well occupies greater pay zone. Physical drainage area of a well is defined either by impermeable physical boundaries or by no-flow boundaries imposed by the interference of nearby wells. During transient flow, wells do not produce from the entire physical drainage area and the physical drainage area does not influence flow and production characteristics. Two possible interpretations of transient flow may be useful for our discussions in this work: at any time during transient flow the distance reached by the pressure pulse due to production at the wellbore is smaller than the distance to the boundary of the drainage area, or production at the wellbore which consists of fluids withdrawn from a distance from the well which is less than the distance to the drainage boundary. It is not uncommon for an unconventional wells to reach the end of their economic life while still producing under transient flow conditions and their physical drainage areas are immaterial for their performances. To apply the conventional techniques of estimating ultimate recovery and recovery factors, it is useful to define a transient drainage area that is smaller than the physical drainage area and a function of time.

The two interpretations of transient flow given above may be used to define the transient drainage area: The first condition leads to the concept of radius of investigation and the second condition yields the definition of effective transient drainage area. Before discussing the concept of transient drainage during transient flow, we considered the relevant literatures [1], [2] on the drainage areas of horizontal and fractured wells.

Experimental part of thesis are based the real data from well #287 of the Shallow Water Gunashli field. This well is vertical. It was analyzed in this experiment that how the hydraulic fracturing treatment affects to well production. It is

shown that when the leg of the horizontal well enter 500 m into productive formation, how this will affect to formation production. Thirdly, when different sizes of the tubing are selected how this will affect well production rate. We will look at 3 different case: base case, hydraulic fracturing and horizontal well.

Drainage area is area which is defined as an internal area between the boundaries of the reservoir. When these boundaries reaches, the well is allowed to flow. In this model, two phase(oil and water) has been considered in the system. We considered the model as a black oil. Viscosity model defined as a Newtonian Fluid. There is no any artificial lift type in the production system, well type is producer. There isn't any sand control method in well and well completed as a cased hole.

This project has been done with Prosper software. It has been included PVT data, petrophysical data, deviation survey data, surface equipment and down-hole equipment data in the program. All these data were same for the vertical and deviated wells. Only, drainage area was larger in deviated well than the vertical well. Based on these given parameters, software calculated the Inflow Performance Relationship curve for both of them. We get different values for the IPR curve in this case.

The basic available PVT data are:

**Basic Reservoir PVT data**

Reservoir Pressure ,psig	3150
ReservoirTemperature,F	200
Oil Gravity ,API	30
Gas Gravity, sp. gravity	0.75
Water Salinity ,ppm	80000
Water Cut,%	0
Total GOR, scf/STB	400

**Table 4.** Reservoir properties from 287 number well

Input data has been matched with the calculated data from program. According to

each pressure, GOR, Oil FVF and viscosity was determined.

Pressure, psig	Gas Oil Ratio, scf /STB	Oil FVF,rb/ STB	Oil viscosity, cP
1500	237	1.138	1.34
2000	324	1.178	1.15
2500	400	1.214	1.01
3000	400	1.207	1.05
4000	400	1.198	1.11

**Table 5.** Match PVT data

The system equipment input section is sub divided into 5 sub–sections:

- Deviation survey
- Surface equipment
- Down-hole equipment
- Geothermal gradient
- Average heat capacities

The deviation survey can have its origin anywhere: wellhead, sea-bed, platform, mean sea level and so on. The key point is to describe all the equipment in the well in a manner consistent with the selected origin.

The wellhead depth does not have coincide with the origin of the deviation survey. This deviation will affect the pressure drop of the commingled flow that arrives at surface. The contribution of each lateral and its impact of pressure drop down hole will be accounted by the IPR model.

### **5.1. Data for hydraulic Fracturing**

The well is drilled around 3000 metres. Productive zone has 30 m thickness and

having 180 md permeability. Other parameters such as porosity, drainage are fracture height was shown in the table below.

The experiment was based on the hydraulic fracturing from the real data of 287 number well in Gunashli field. Three cases are analyzed for production forecast:

- Production in a base case (vertical well)
- Production from hydraulically fractured well at different angles
- Production from horizontal well into productive zone at different angles

Reservoir Permeability, md	180
Reservoir thickness, m	30
Drainage Area, m <sup>2</sup>	77494,3
Dietz Shape Factor	1,96133
wellbore radius, m	0,07
Time, days	1
Reservoir porosity	0,2
Fracture height, m	30,48
Fracture half length, m	9,144

**Table 6.** Data for hydraulic fracturing

In fig 22, gas production was determined for each case. If hydraulic fracturing is applied, production will importantly demonstrate an increase. When the well enter the pay zone 500 m in horizontal direction, production will rise to its maximum number. In table 7, gas production rate was shown in the selection of different tubing sizes in basic case. At the same tubing sizes, when HF was done and the well is drilled at horizontal case, number of the production rates were shown.



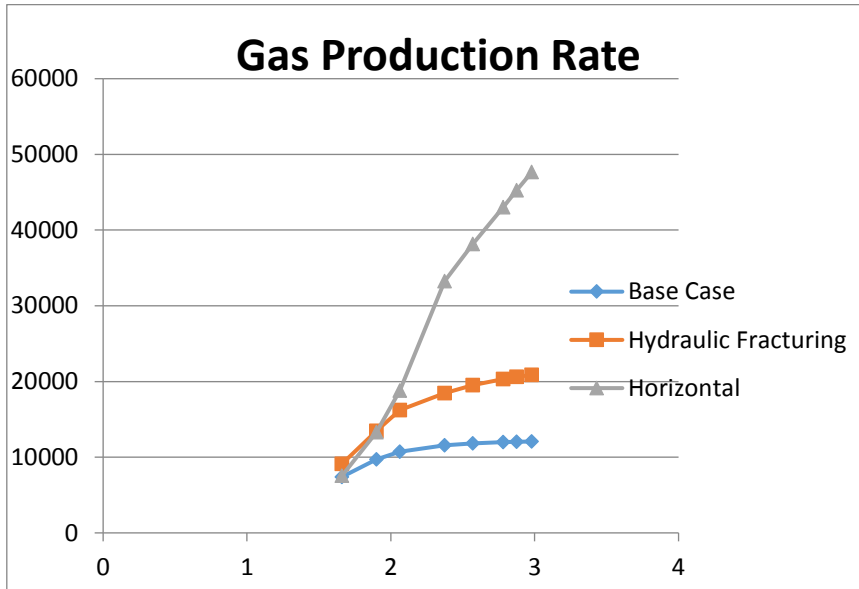
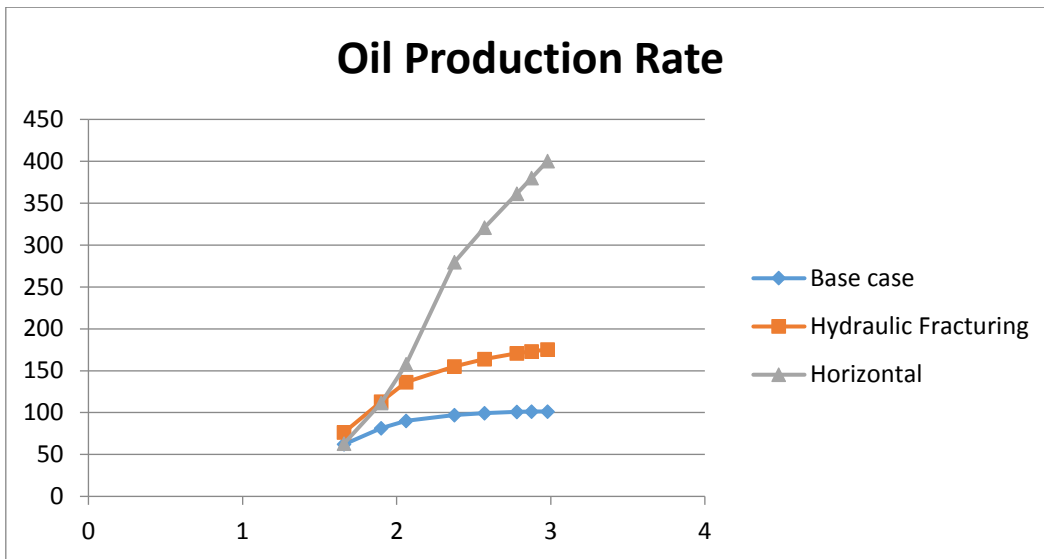

**Figure 22.** Gas Production Rate in different tubing diameter sizes.

Parameters	GUN_287_basic	GUN_287_hydraulic_fracturing	GUN_287_length_of_horizontal_section
Tubing diameter(inch)	Gas Rate(m3/day)	Gas Rate(m3/day)	Gas Rate(m3/day)
1,66	7398,5	9115	7537,6
1,9	9693,7	13463	13291
2,063	10717,5	16221,1	18787,7
2,375	11549,5	18453,2	33268,3
2,57	11839,2	19507,3	38172,9
2,78	12010,2	20337,8	43024,5
2,875	12049,6	20615	45244,9
2,98	12072,8	20864,1	47663,1

**Table 7.** Gas Production Rate in different tubing diameter sizes.

As like gas production rate in the different tubing size, HF and horizontal case, oil production was determined for the same applications.

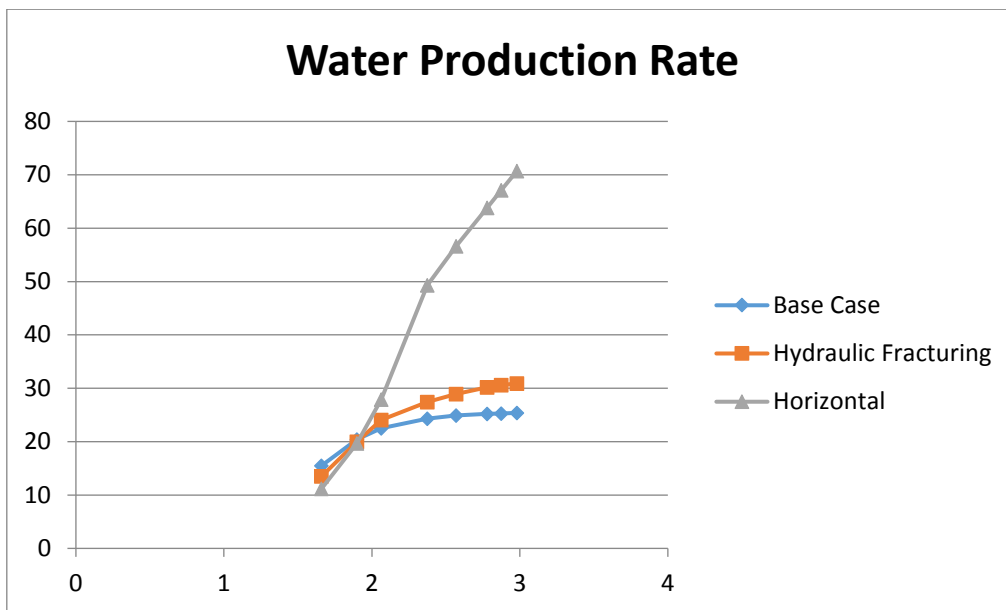

**Figure 23.** Oil Production Rate in different tubing diameter sizes.

Parameters	GUN_287_ba sic	GUN_287_hydraulic_fract uring	GUN_287_length_of_horizontal_s ection
Tubing diameter(inch)	Oil Rate(m3/day)	Oil Rate(m3/day)	Oil Rate(m3/day)
1,66	62,2	76,6	63,3
1,9	81,5	113,1	111,7
2,063	90,1	136,3	157,9
2,375	97	155,1	279,6
2,57	99,5	163,9	320,8
2,78	100,9	170,9	361,5
2,875	101,3	173,2	380,2
2,98	101,4	175,3	400,5

**Table 8.** Oil Production Rate in different tubing diameter sizes.

For example, in the application of 2.98 inch tubing, oil production rate is 101.4 m<sup>3</sup>/day for base case , if hydraulic fracturing was done in this well, oil rate will increase to 175.3 m<sup>3</sup>/day, but with horizontal well to productive zone, oil rate is at its peak (400.5 m<sup>3</sup>/day).

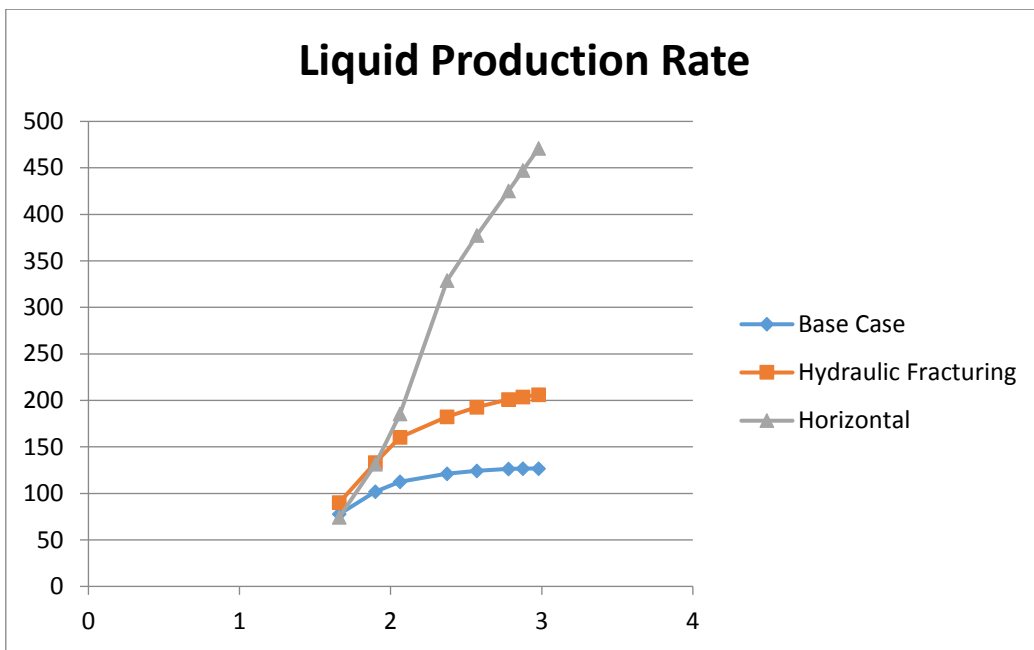

**Fig.24.** Water Production Rate in different tubing diameter sizes.

Parameters	GUN_287_bas ic	GUN_287_hydraulic_fractur ing	GUN_287_length_of_horizontal_sec tion
Tubing diameter(ih)	Water Rate(m3/day)	Water Rate(m3/day)	Water Rate(m3/day)
1,66	15,5	13,5	11,2
1,9	20,4	20	19,7
2,063	22,5	24,1	27,9
2,375	24,3	27,4	49,3
2,57	24,9	28,9	56,6
2,78	25,2	30,2	63,8
2,875	25,3	30,6	67,1
2,98	25,4	30,9	70,7

**Table 9.** Water Production Rate in different tubing diameter sizes.

Consequently, from these graphs and tables, it is understood that, when the tubing size increases, it affects significantly gas, water and oil production rates, production of the each phase increases.



**Figure 25.** Liquid Production Rate in different tubing diameter sizes.

Parameters	GUN_287_basic	GUN_287_hydraulic_fracturing	GUN_287_length_of_horizontal_section
Tubing diameter(inch)	Liquid Rate(m3/day)	Liquid Rate(m3/day)	Liquid Rate(m3/day)
1,66	77,7	90,1	74,5
1,9	101,8	133,1	131,4
2,063	112,6	160,4	185,7
2,375	121,3	182,4	328,9
2,57	124,4	192,8	377,4
2,78	126,2	201,1	425,3
2,875	126,6	203,8	447,3
2,98	126,8	206,3	471,2

**Table 10.** Liquid Production Rate in different tubing diameter sizes.

Liquid as we know is mixture both oil and water phases. For instance, If we take 2.98 inch tubing size, liquid rate for basic case is 126.8 m3/day, for hydraulic fracturing

technic the rate is 206.3 m<sup>3</sup>/day and finally if the well is drilled in horizontal direction, liquid rate is 471.2 m<sup>3</sup>/day.

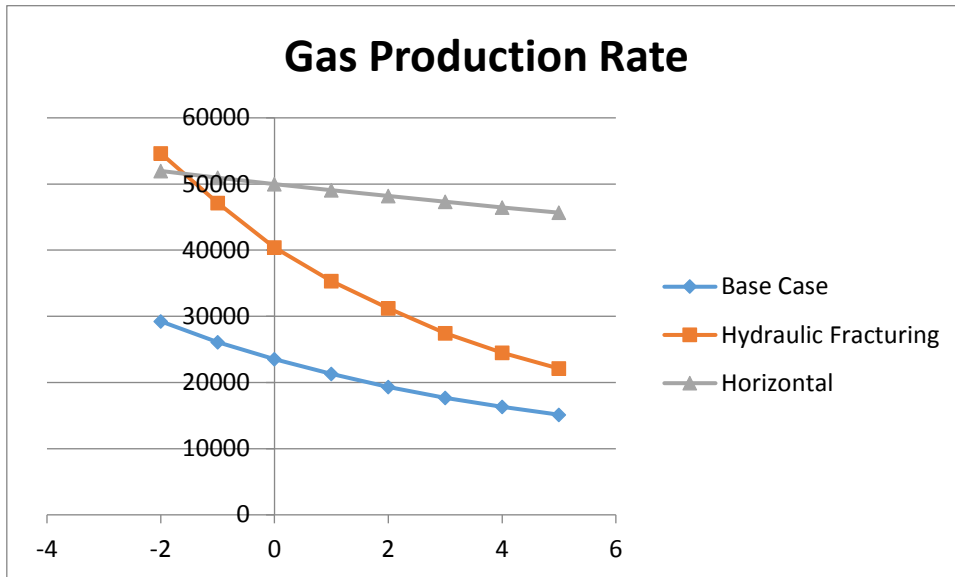

**Figure 26.** Gas Production Rates in different skin factor values

Parameters	GUN_287_basic	GUN_287_hydraulic_fracturing	GUN_287_length_of_horizontal_section
Skin factor	Gas Rate(m <sup>3</sup> /day)	Gas Rate(m <sup>3</sup> /day)	Gas Rate(m <sup>3</sup> /day)
-2	29245,8	54643,5	51973,8
-1	26075,6	47149,5	50968,4
0	23525,6	40392,4	50001,1
1	21303,1	35329,3	49069,8
2	19333,7	31232,2	48172,6
3	17697,7	27454,7	47307,6
4	16316,9	24492,4	46473,2
5	15136	22107,1	45667,6

**Table 11.** Gas Production Rates in different skin factor values

Skin can be in two forms: positive skin and negative skin. Positive skin means that the well has additional pressure drop based on either form of the formation damage. Negative skin means that production has enhanced by create high permeable channels

and remove the reason which cause to reduction in the permeability. The skin value can range from -6 which created high conductivity channels by well stimulation to any positive value which depends on formation damage type.

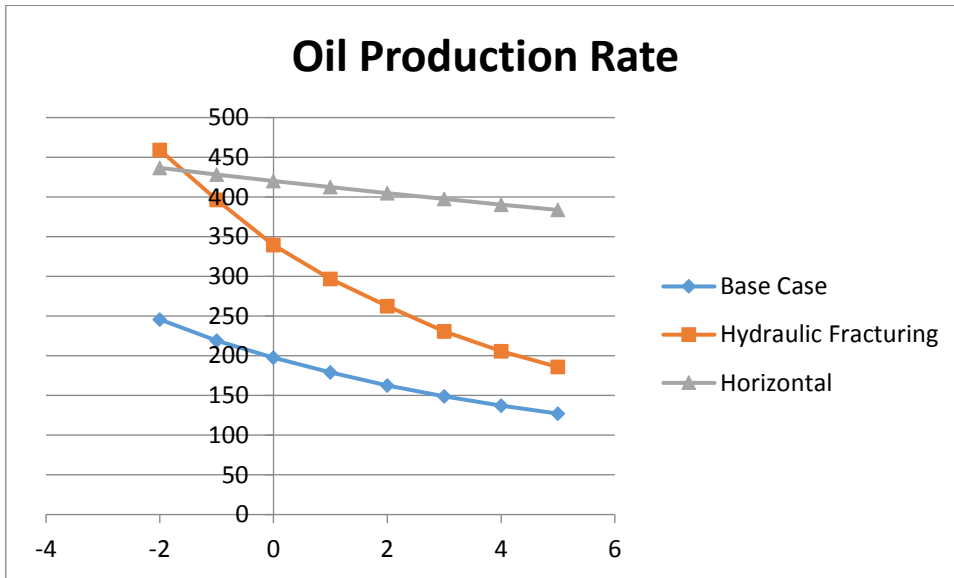

**Figure 27.** Oil Production Rates in different skin factor values

Parameters	GUN_287_basic	GUN_287_hydraulic_fracturing	GUN_287_length_of_horizontal_section
Skin factor	Oil Rate(m3/day)	Oil Rate(m3/day)	Oil Rate(m3/day)
-2	245,8	459,2	436,7
-1	219,1	396,2	428,3
0	197,7	339,4	420,2
1	179	296,9	412,3
2	162,5	262,4	404,8
3	148,7	230,7	397,5
4	137,1	205,8	390,5
5	127,2	185,8	383,7

**Table 12.** Oil Production Rates in different skin factor values

From fig 26, oil production rate was defined in the various values of the skin factor. From graph above, in the value of -1 skin, rate for basic case is 219.1 m3/day, for HF applied, rate is 396.2 m3/day, for horizontal well drilled, the rate is 428.3 m3/day. Unlike greater production rates due to negative skin, in positive skin, production

decreased according to reduced wellbore permeability. For example, in value of +5 skin, rate for basic case is 127.2, for HF applied, the production rate is 185.8 m<sup>3</sup>/day, for the case of horizontal well drilled, rate is 383.7. If we have a look to the values of production rates in both positive and negative skin, we can see how oil production differentiates importantly from each other.

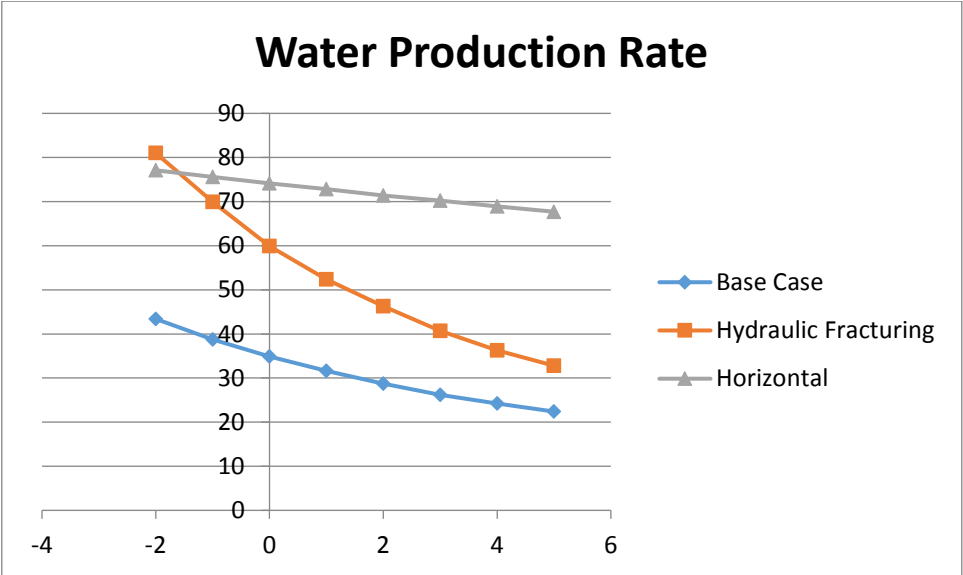

**Figure 28.** Water Production Rates in different skin factor values

Parameters	GUN_287_basic	GUN_287_hydraulic_fracturing	GUN_287_length_of_horizontal_section
Skin factor	Water Rate(m <sup>3</sup> /day)	Water Rate(m <sup>3</sup> /day)	Water Rate(m <sup>3</sup> /day)
-2	43,4	81	77,1
-1	38,7	69,9	75,6
0	34,9	59,9	74,1
1	31,6	52,4	72,8
2	28,7	46,3	71,4
3	26,2	40,7	70,2
4	24,2	36,3	68,9
5	22,4	32,8	67,7

**Table 13.** Water Production Rates in different skin factor values

Water production rate in the positive and negative skin condition was determined.

Significantly, with positive skin occurred, decrease in liquid production rate was shown from both graph and table above.

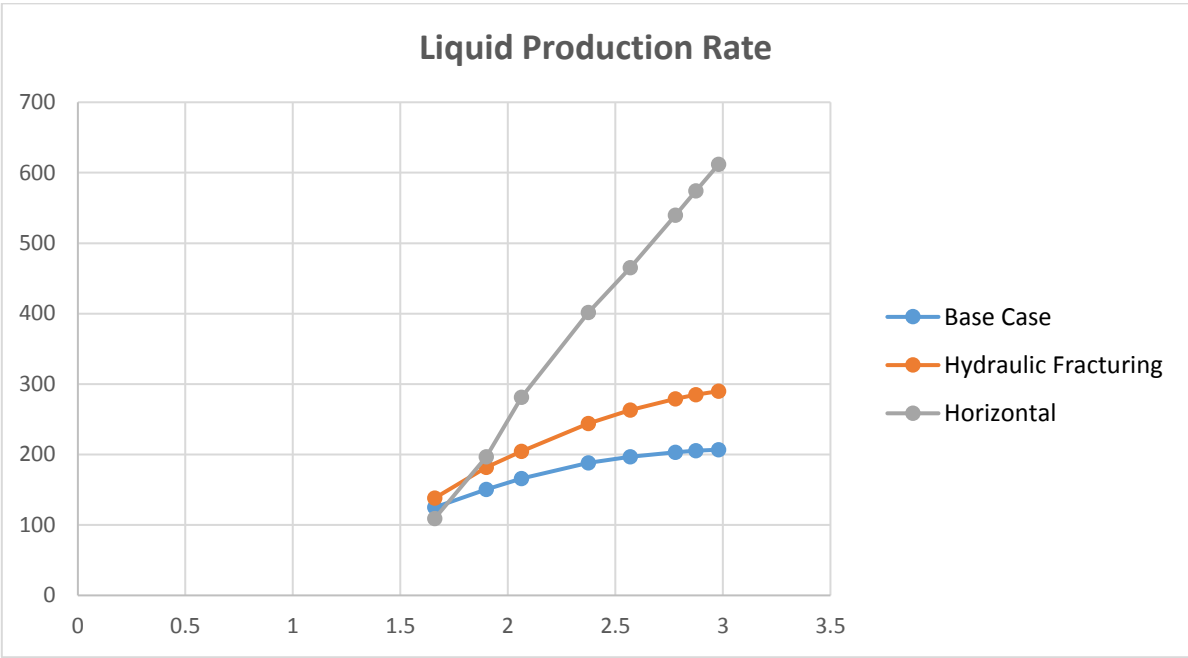

**Figure 29.** Liquid Production Rates in different tubing diameter sizes in 30 angle inclination

Parameters	GUN_287_30	GUN_287_30_hydraulic_fracturing	GUN_287_30_length_of_horizontal_section
Tubing diameter(inch)	Liquid Rate(m3/day)	Liquid Rate(m3/day)	Liquid Rate(m3/day)
1,66	125	138,2	109,3
1,9	150,6	181,9	196,9
2,063	166	204,6	281,2
2,375	188,1	244,1	401,6
2,57	196,9	263,3	465,2
2,78	203,2	279,2	539,8
2,875	205,2	284,8	574,2
2,98	206,8	289,9	611,9

**Table 14.** Liquid Production Rates in different tubing diameter sizes in 30 angle



inclination

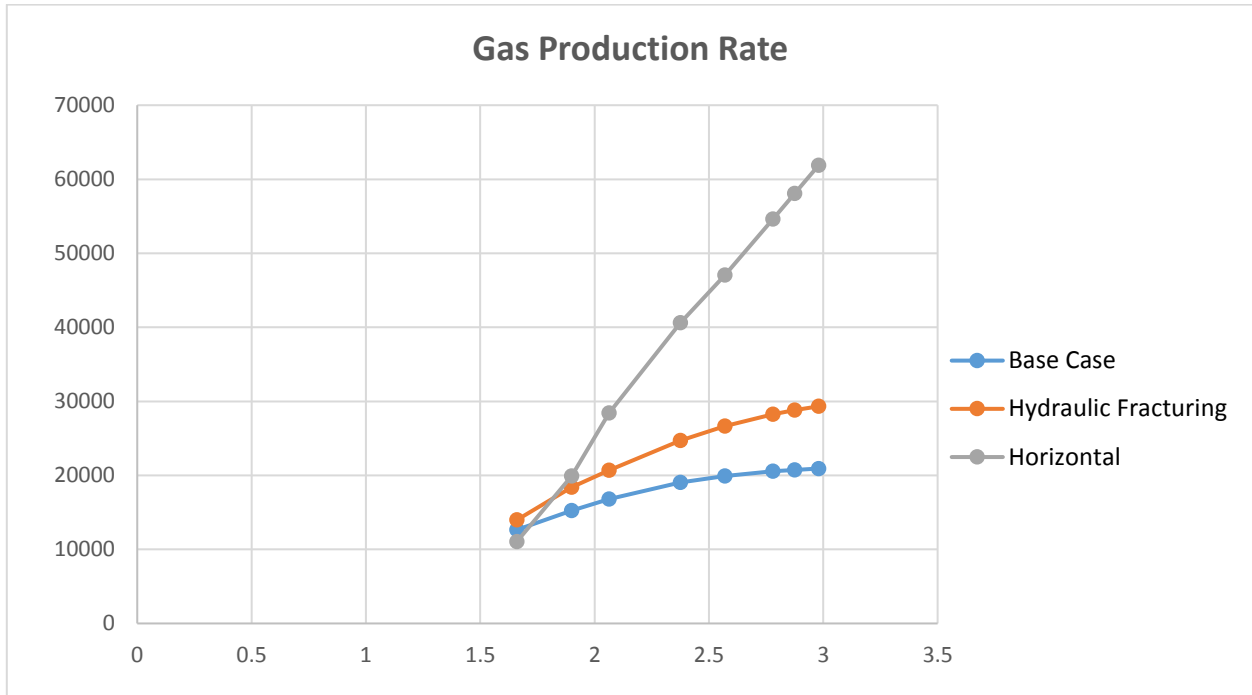

**Figure 30.** Gas Production Rates in different tubing diameter sizes in 30 angle inclination

Parameters	GUN_287_30	GUN_287_30_hydraulic_fracturing	GUN_287_30_length_of_horizontal_section
Tubing diameter(inch)	Gas Rate(m3/day)	Gas Rate(m3/day)	Gas Rate(m3/day)
1,66	12648,4	13977,5	11058,5
1,9	15234,7	18402,6	19915,7
2,063	16795,4	20700,5	28444,5
2,375	19029,2	24693,8	40622,9
2,57	19919,3	26638	47053,5
2,78	20553,5	28243,7	54601,5
2,875	20752,5	28804,8	58084,6
2,98	20923,4	29329	61899,3

**Table 15.** Gas Production Rates in different tubing diameter sizes in 30 angle inclination

In table 14, gas production rates were defined for base case, HF and horizontal well

drilled when the well enters into productive zone at the inclination of 30 angle after 2600 m. When the 2.98 inch tubing was chosen, production rate for base case with 30 angle inclination deviated well is 20923 m<sup>3</sup>/day, rate for HF, 29329 m<sup>3</sup>/day, rate for 30 angle horizontal section is 61899,3 m<sup>3</sup>/day.

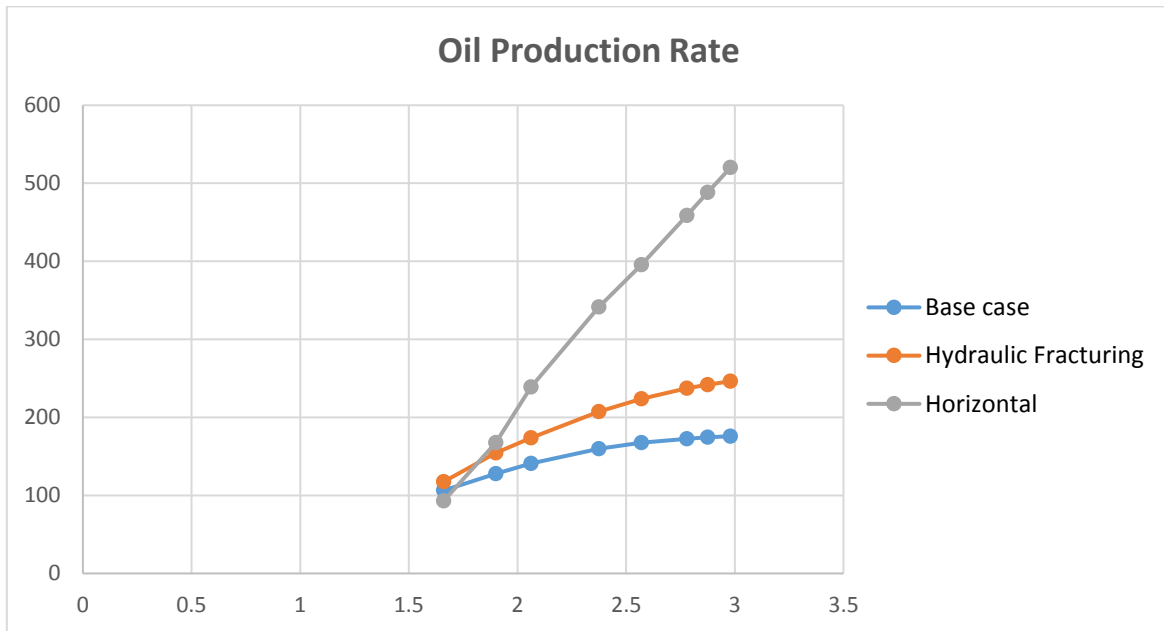

**Figure 31.** Oil Production Rates in different tubing diameter sizes in 30 angle inclination

Parameters	GUN_287_30	GUN_287_30_hydraulic_fracturing	GUN_287_30_length_of_horizontal_section
Tubing diameter(inch)	Oil Rate(m <sup>3</sup> /day)	Oil Rate(m <sup>3</sup> /day)	Oil Rate(m <sup>3</sup> /day)
1,66	106,3	117,5	92,9
1,9	128	154,6	167,4
2,063	141,1	173,9	239
2,375	159,9	207,5	341,4
2,57	167,4	223,8	395,4
2,78	172,7	237,3	458,8
2,875	174,4	242	488,1
2,98	175,8	246,4	520,1

**Table 16.** Oil Production Rates in different tubing diameter sizes in 30 angle

inclination

The same principle in gas production, oil production rate were found for base case, HF and horizontal well when the well goes into formation at 30 angle inclination after 2600m. For instance, if 2.78 inch of tubing was picked up, oil rate for base with 30 angle deviated well is 172.4 m<sup>3</sup>/day, rate for HF through 30 angle deviated well is 237.3 m<sup>3</sup>/day, rate for 30 angle horizontal well is 458.8 m<sup>3</sup>/day.

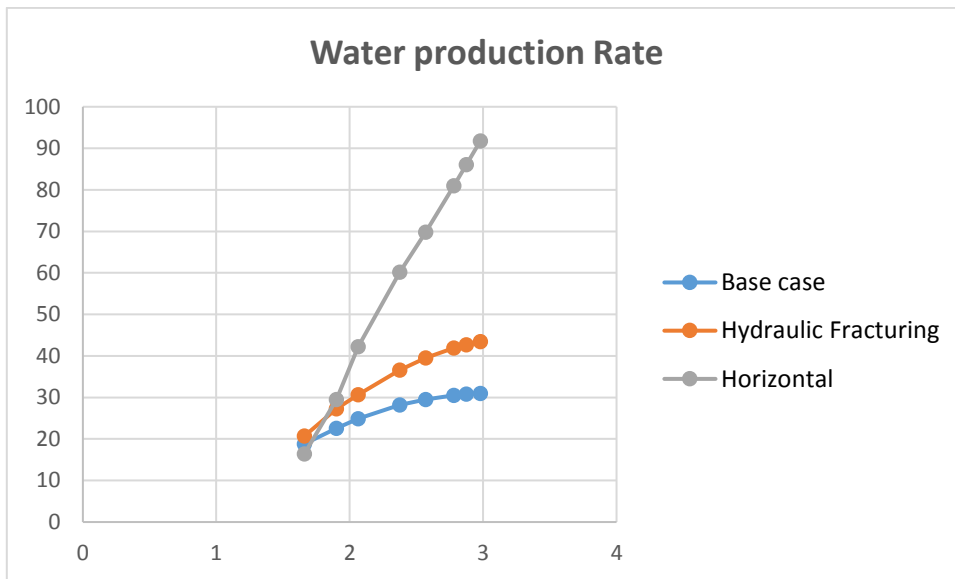

**Figure 32.** Water Production Rates in different tubing diameter sizes in 30 angle inclination

Parameters	GUN_287_30	GUN_287_30_hydraulic_fracturing	GUN_287_30_length_of_horizontal_section
Tubing diameter(inch)	Water Rate(m <sup>3</sup> /day)	Water Rate(m <sup>3</sup> /day)	Water Rate(m <sup>3</sup> /day)
1,66	18,8	20,7	16,4
1,9	22,6	27,3	29,5
2,063	24,9	30,7	42,2
2,375	28,2	36,6	60,2
2,57	29,5	39,5	69,8
2,78	30,5	41,9	81
2,875	30,8	42,7	86,1

2,98	31	43,5	91,8
------	----	------	------

**Table 17.** Water Production Rates in different tubing diameter sizes in 30 angle inclination

Water production was analyzed for base case which is drilled with 30 angle deviated well. This analyses is repeated for the same well which additional hydraulic fracturing method is applied. Next step of the analyses was done with 30 angle horizontal well drilled 500 m into productive zone.

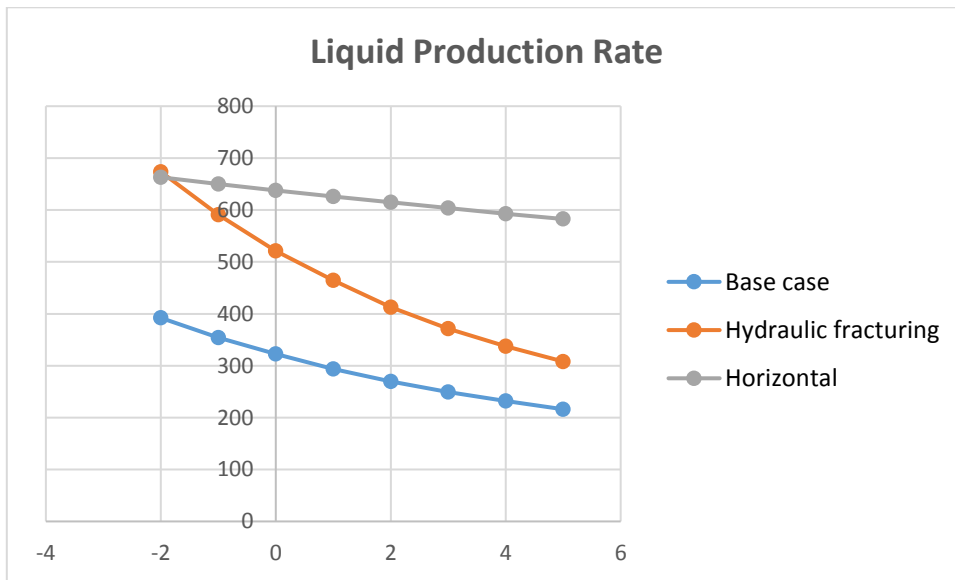

**Figure 33.** Liquid Production Rates in different skin factor values in 30 angle inclination

Parameters	GUN_287_30	GUN_287_30_hydraulic_fracturing	GUN_287_30_length_of_horizontal_section
Skin factor	Liquid Rate(m3/day)	Liquid Rate(m3/day)	Liquid Rate(m3/day)
-2	392,1	673,5	663,1
-1	354,4	590,9	650,3
0	322,5	521	638
1	293,7	464,4	626,1
2	269,7	412,7	614,7
3	249,3	371,4	603,6
4	231,8	337,6	593
5	216,1	308,1	582,7

**Table 18.** Liquid Production Rates in different skin factor values in 30 angle inclination

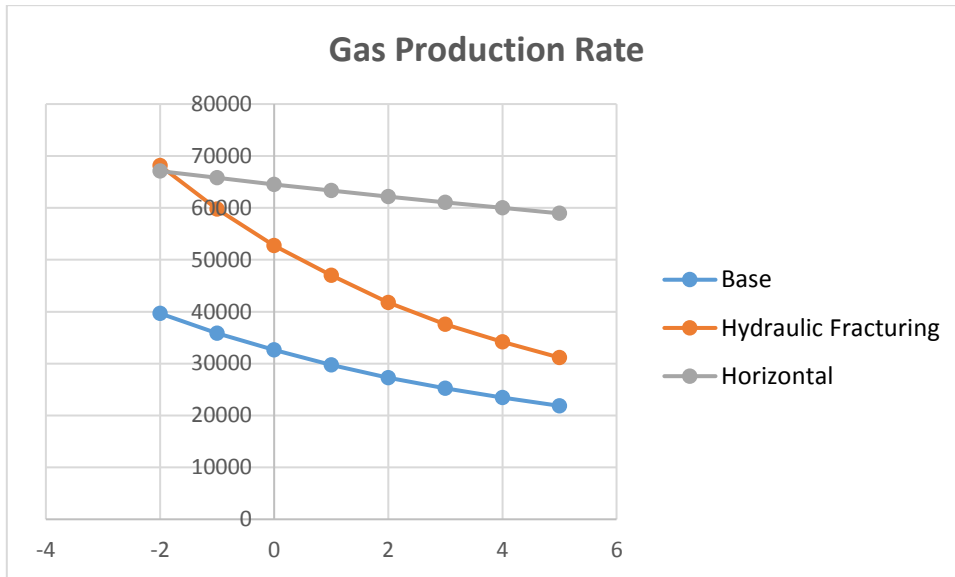
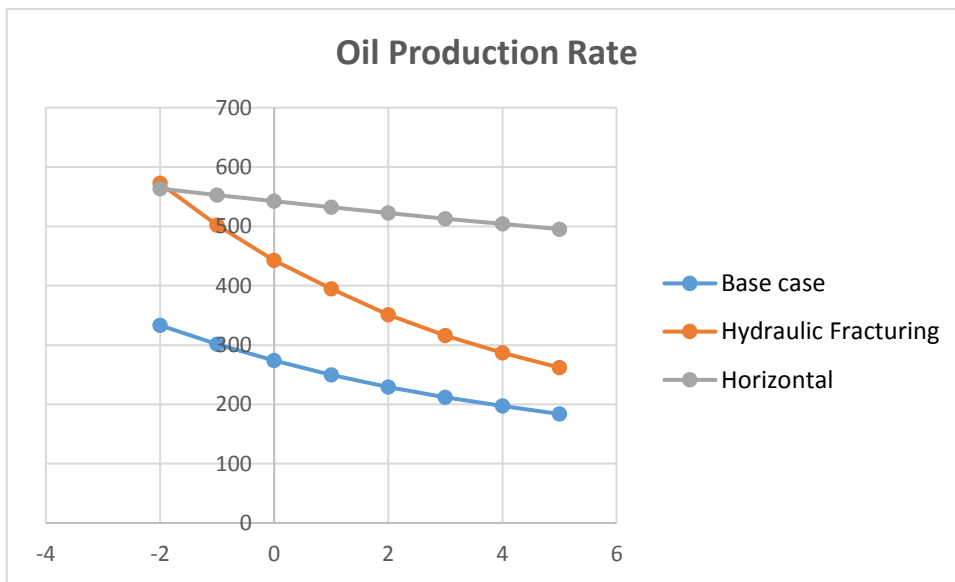

**Figure 34.** Gas Production Rates in different skin factor values in 30 angle inclination

Parameters	GUN_287_30	GUN_287_30_hydraulic_fracturing	GUN_287_30_length_of_horizontal_section
Skin factor	Gas Rate(m3/day)	Gas Rate(m3/day)	Gas Rate(m3/day)
-2	39666,8	68125,9	67077,9
-1	35846,3	59770,9	65781,6
0	32621	52706,3	64534,3
1	29713,2	46980	63333,5
2	27281,4	41749,5	62176,6
3	25217,5	37566,9	61061,2
4	23443,9	34146,1	59985
5	21861,4	31164,3	58946,2

**Table 19.** Gas Production Rates in different skin factor values in 30 angle inclination

In a figure of +2 Skin factor, production rates falls in the comparison with negative skin. In this value of the skin ,in the condition of drilling under 30 degree for base case, gas rate is 27.281.4.m3/day, for the hydraulic fracturing done production rose to 41749.5 m3/day and for the same well parameters drilled as horizontal case, production rate is showing 62176.6 m3/day.

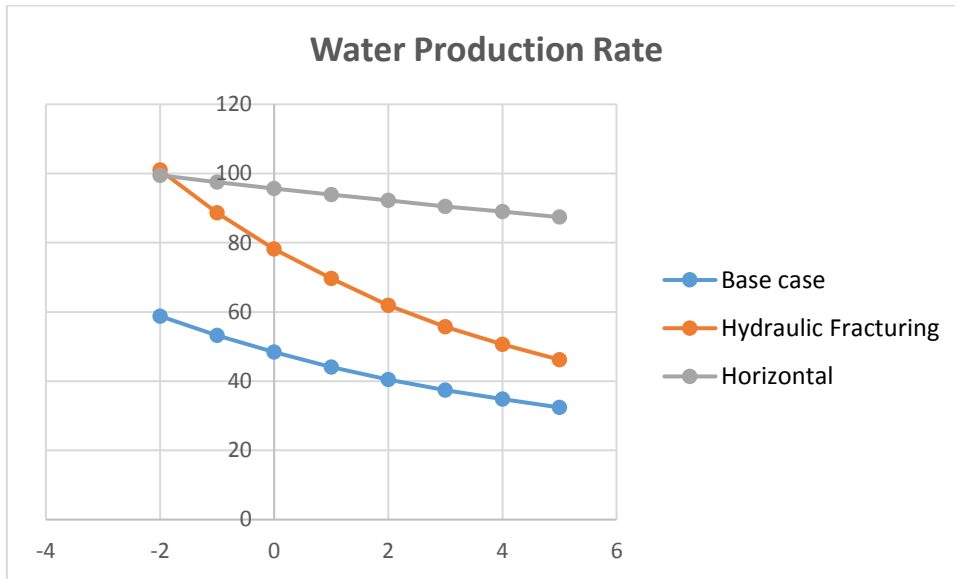

**Figure 35.** Oil Production Rates in different skin factor values in 30 angle inclination

Parameters	GUN_287_30	GUN_287_30_hydraulic_fracturing	GUN_287_30_length_of_horizontal_section
Skin factor	Oil Rate(m3/day)	Oil Rate(m3/day)	Oil Rate(m3/day)
-2	333,3	572,5	563,7
-1	301,2	502,3	552,8
0	274,1	442,9	542,3
1	249,7	394,8	532,2
2	229,2	350,8	522,5
3	211,9	315,7	513,1
4	197	286,9	504,1
5	183,7	261,9	495,3

**Table 20.** Oil Production Rates in different skin factor values in 30 angle inclination

This graph was analysed for oil rate. In the value of +4 skin, production rate for base drilled at 30 angle is 197 m<sup>3</sup>/day. Rate for the same well hydraulic fracturing applied at 30 angle inclination is 286.9 m<sup>3</sup>/day. Rate for horizontal well drilled at 30 degree inclination is 504.1 m<sup>3</sup>/day.

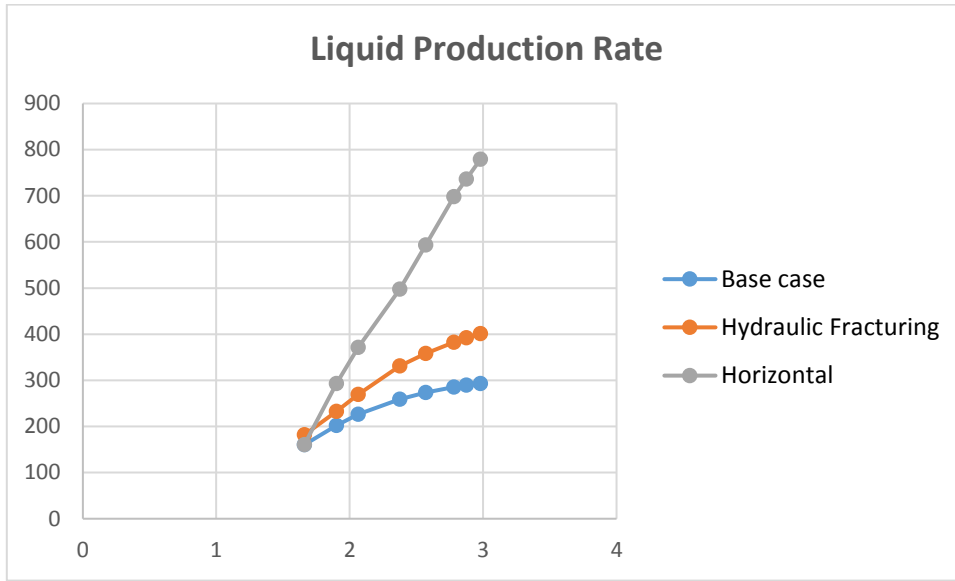

**Figure 36.** Water Production Rates in different skin factor values in 30 angle inclination

Parameters	GUN_287_30	GUN_287_30_hydraulic_fracturing	GUN_287_30_length_of_horizontal_section
Skin factor	Water Rate(m <sup>3</sup> /day)	Water Rate(m <sup>3</sup> /day)	Water Rate(m <sup>3</sup> /day)
-2	58,8	101	99,5
-1	53,2	88,6	97,5
0	48,4	78,2	95,7
1	44,1	69,7	93,9
2	40,5	61,9	92,2
3	37,4	55,7	90,5
4	34,8	50,6	89
5	32,4	46,2	87,4

**Table 21.** Water Production Rates in different skin factor values in 30 angle

inclination



**Figure 37.** Liquid Production Rates in different tubing diameter sizes in 45 angle inclination

Parameters	GUN_287_45	GUN_287_45_hydraulic_fracturing	GUN_287_45_length_of_horizontal_section
Tubing diameter(inch)	Liquid Rate(m3/day)	Liquid Rate(m3/day)	Liquid Rate(m3/day)
1,66	160,4	181,8	160,5
1,9	202,3	232,6	293,2
2,063	226,6	269,6	371,5
2,375	258,9	331	497,4
2,57	273,6	358,3	593,6
2,78	285,2	382,8	697,8
2,875	289,2	392	736,1
2,98	292,8	401	779,1

**Table 22.** Liquid Production Rates in different tubing diameter sizes in 45 angle inclination

Liquid production rate for different tubing sizes for different inclination was shown in a table above. For 2.57 inch tubing selected, production rate for base case drilled at 45



degree inclination is 273.6 m<sup>3</sup>/day. Liquid rate for the same well with HF applied is 358.3 m<sup>3</sup>/day, rate for horizontal well drilled at 45 angle inclination is 593.6 m<sup>3</sup>/day.

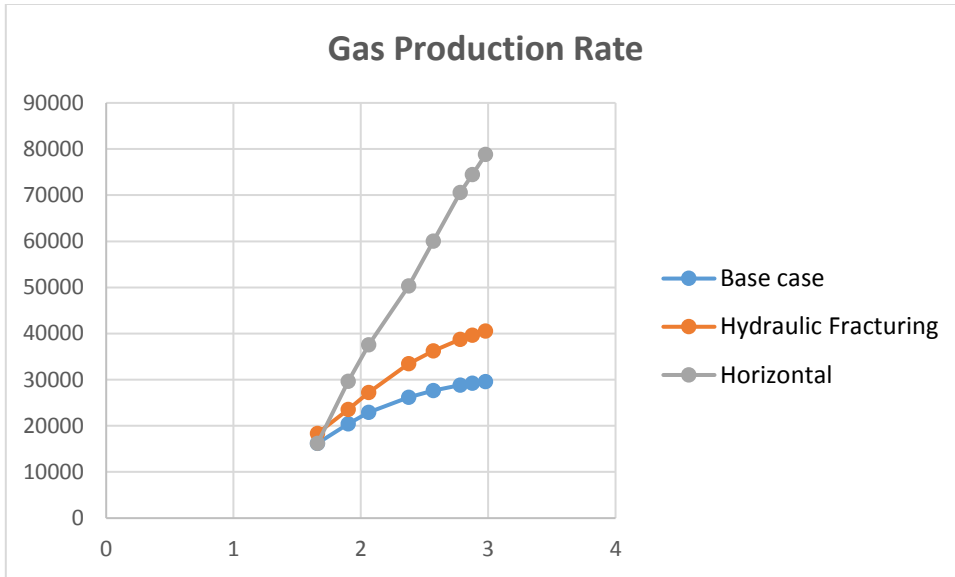

**Fig.38.** Gas Production Rates in different tubing diameter sizes in 45 angle inclination

Parameters	GUN_287_45	GUN_287_45_hydraulic_fracturing	GUN_287_45_length_of_horizontal_section
Tubing diameter(inch)	Gas Rate(m <sup>3</sup> /day)	Gas Rate(m <sup>3</sup> /day)	Gas Rate(m <sup>3</sup> /day)
1,66	16226,8	18388	16231,5
1,9	20468,3	23532,8	29661,3
2,063	22918,1	27267,3	37576,2
2,375	26194	33486	50313,6
2,57	27680,3	36241,9	60047,4
2,78	28850,8	38726,7	70590,9
2,875	29251,8	39657,4	74459,2
2,98	29617,5	40560,6	78807,8

**Table 23.** Gas Production Rates in different tubing diameter sizes in 45 angle inclination

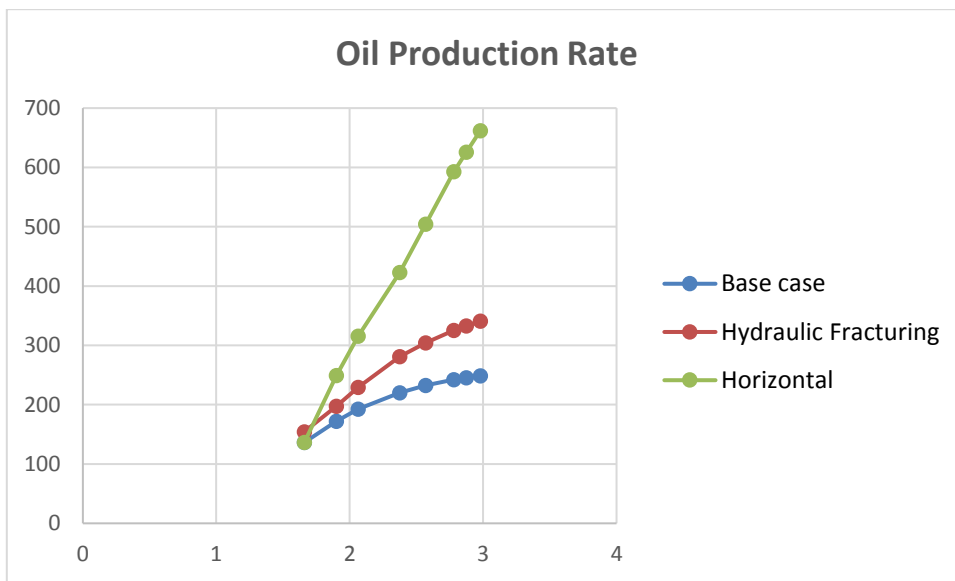

**Figure 39.** Oil Production Rates in different tubing diameter sizes in 45 angle inclination

Parameters	GUN_287_45	GUN_287_45_hydraulic_fracturing	GUN_287_45_length_of_horizontal_section
Tubing diameter(inch)	Oil Rate(m3/day)	Oil Rate(m3/day)	Oil Rate(m3/day)
1,66	136,4	154,5	136,4
1,9	172	197,7	249,2
2,063	192,6	229,1	315,8
2,375	220,1	281,4	422,8
2,57	232,6	304,5	504,6
2,78	242,4	325,4	593,2
2,875	245,8	333,2	625,7
2,98	248,9	340,8	662,2

**Table 24.** Oil Production Rates in different tubing diameter sizes in 45 angle inclination

Oil production rate in 2.375 inch tubing for base case drilled at 45 angle inclination is 220.1m3/day. Rate for hydraulic fracturing applied in this well drilled at 45 degree

inclination is 281.4 m<sup>3</sup>/day. Rate for horizontal well drilled at 45 angle is 422.8 m<sup>3</sup>/day.

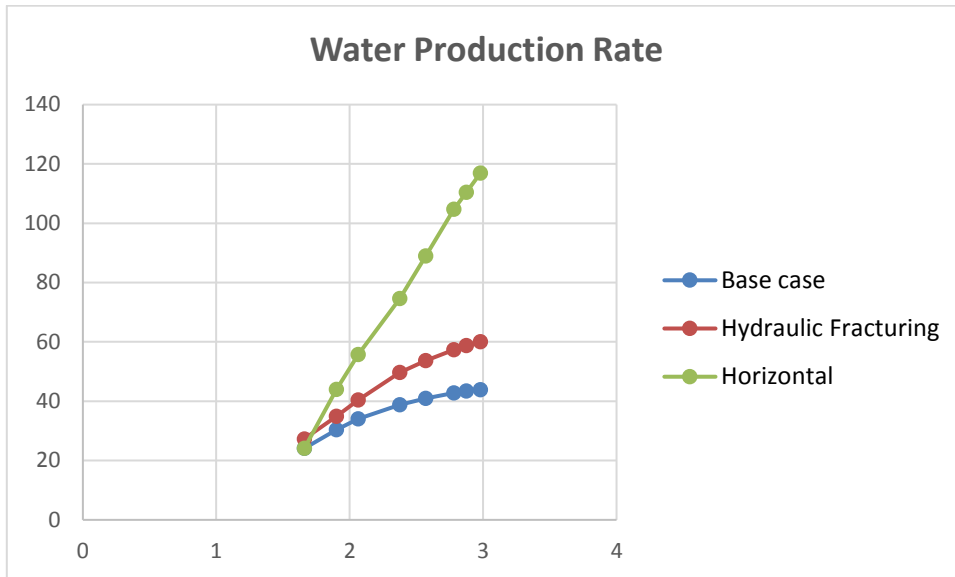
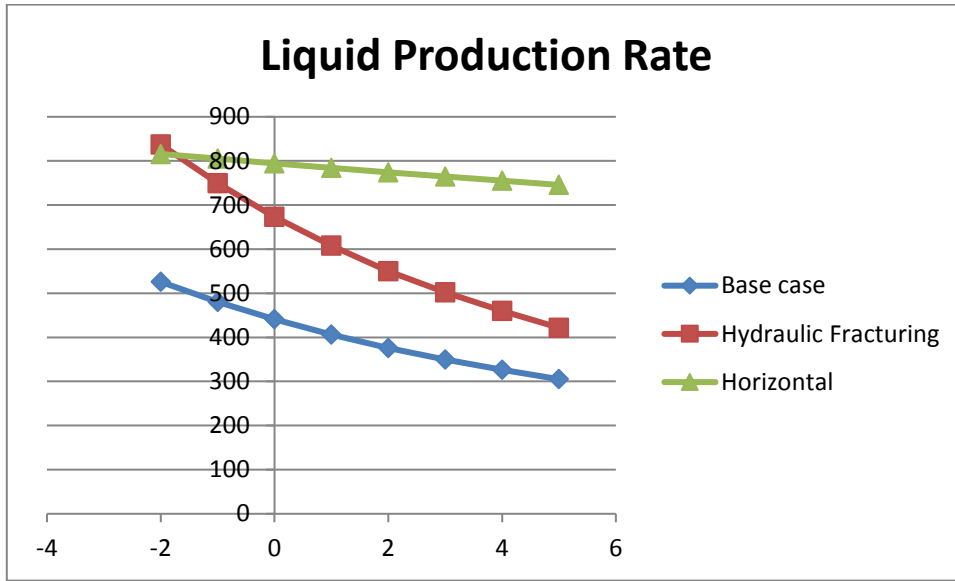

**Figure 40.** Water Production Rates in different tubing diameter sizes in 45 angle inclination

Parameters	GUN_287_45	GUN_287_45_hydraulic_fracturing	GUN_287_45_length_of_horizontal_section
Tubing diameter (inch)	Water Rate (m <sup>3</sup> /day)	Water Rate (m <sup>3</sup> /day)	Water Rate (m <sup>3</sup> /day)
1,66	24,1	27,3	24,1
1,9	30,4	34,9	44
2,063	34	40,4	55,7
2,375	38,8	49,7	74,6
2,57	41	53,7	89
2,78	42,8	57,4	104,7
2,875	43,4	58,8	110,4
2,98	43,9	60,1	116,9

**Table 25.** Water Production Rates in different tubing diameter sizes in 45 angle

inclination



**Figure 41.** Liquid Production Rates in different skin factor values in 45 angle inclination

Parameters	GUN_287_45	GUN_287_45_hydraulic_fracturing	GUN_287_45_length_of_horizontal_section
Skin factor	Liquid Rate(m3/day)	Liquid Rate(m3/day)	Liquid Rate(m3/day)
-2	525,8	837,1	815,7
-1	479,9	749,4	804,9
0	441,3	673,2	794,4
1	405,9	608,1	784,1
2	375,6	550	774,1
3	349,5	502,1	764,4
4	326,5	460,2	754,9
5	305,1	421,8	745,6

**Table 26.** Liquid Production Rates in different skin factor values in 45 angle inclination.

Liquid production rate in the figure of -1 skin for base case drilled at 45 degree inclination is 479.9 m3/day. Liquid rate for hydraulic fracturing in this well is 749.4

m<sup>3</sup>/day. Production rate in the horizontal well drilled at 45 angle inclination is 804.9 m<sup>3</sup>/day.

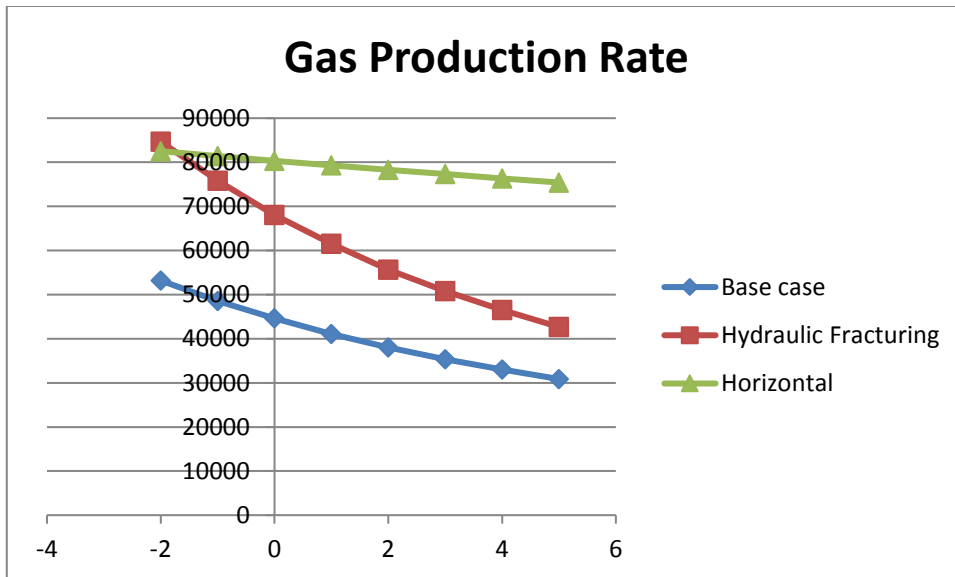

**Figure 42.** Gas Production Rates in different skin factor values in 45 angle inclination

Parameters	GUN_287_45	GUN_287_45_hydraulic_fracturing	GUN_287_45_length_of_horizontal_section
Skin factor	Gas Rate(m <sup>3</sup> /day)	Gas Rate(m <sup>3</sup> /day)	Gas Rate(m <sup>3</sup> /day)
-2	53187,9	84681,9	82514,8
-1	48542,3	75806,8	81420,8
0	44643	68094,9	80355,4
1	41059,5	61512,7	79317,6
2	37993,1	55638,9	78306,3
3	35353	50789,1	77320,4
4	33030,4	46547,7	76359
5	30859,3	42665,6	75421,2

**Table 27.** Gas Production Rates in different skin factor values in 45 angle inclination

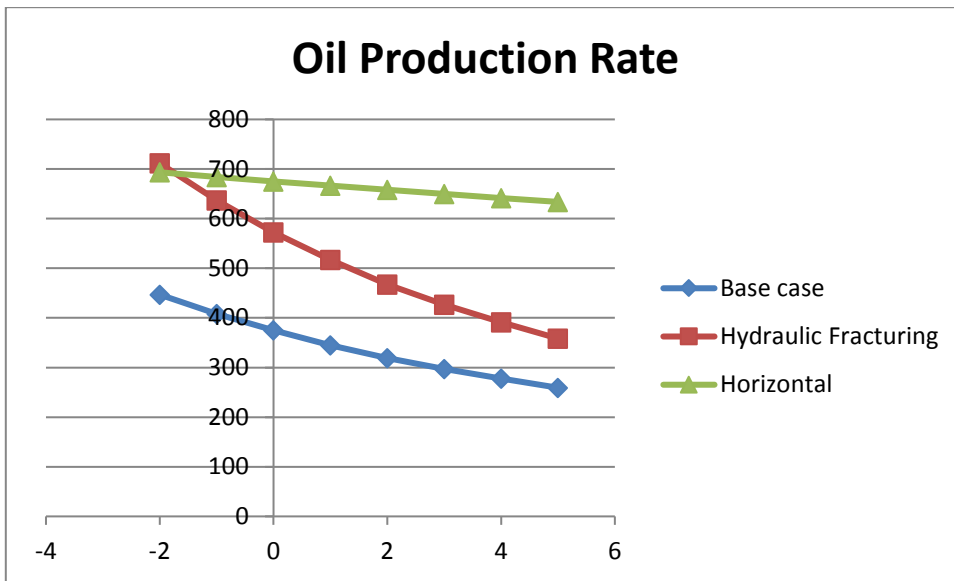

**Figure 43.** Oil Production Rates in different skin factor values in 45 angle inclination

Parameters	GUN_287_45	GUN_287_45_hydraulic_fracturing	GUN_287_45_length_of_horizontal_section
Skin factor	Oil Rate(m3/day)	Oil Rate(m3/day)	Oil Rate(m3/day)
-2	446,9	711,6	693,4
-1	407,9	637	684,2
0	375,1	572,2	675,2
1	345	516,9	666,5
2	319,3	467,5	658
3	297,1	426,8	649,7
4	277,6	391,1	641,6
5	259,3	358,5	633,8

**Table 28.** Oil Production Rates in different skin factor values in 45 angle inclination

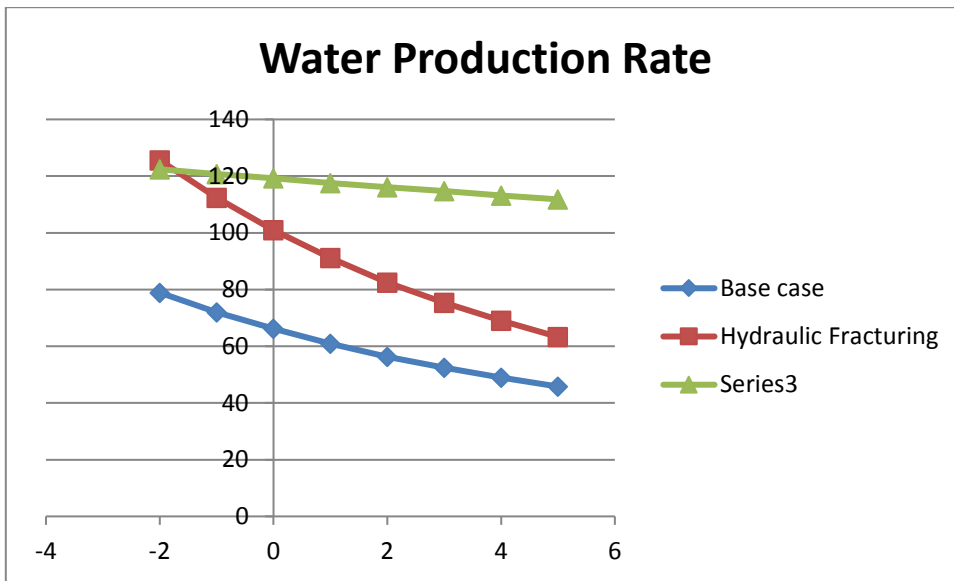

**Figure 44.** Water Production Rates in different skin factor values in 45 angle inclination

Parameters	GUN_287_45	GUN_287_45_hydraulic_fracturing	GUN_287_45_length_of_horizontal_section
Skin factor	Water Rate(m3/day)	Water Rate(m3/day)	Water Rate(m3/day)
-2	78,9	125,6	122,4
-1	72	112,4	120,7
0	66,2	101	119,2
1	60,9	91,2	117,6
2	56,3	82,5	116,1
3	52,4	75,3	114,7
4	49	69	113,2
5	45,8	63,3	111,8

**Table 29.** Water Production Rates in different skin factor values in 45 angle inclination

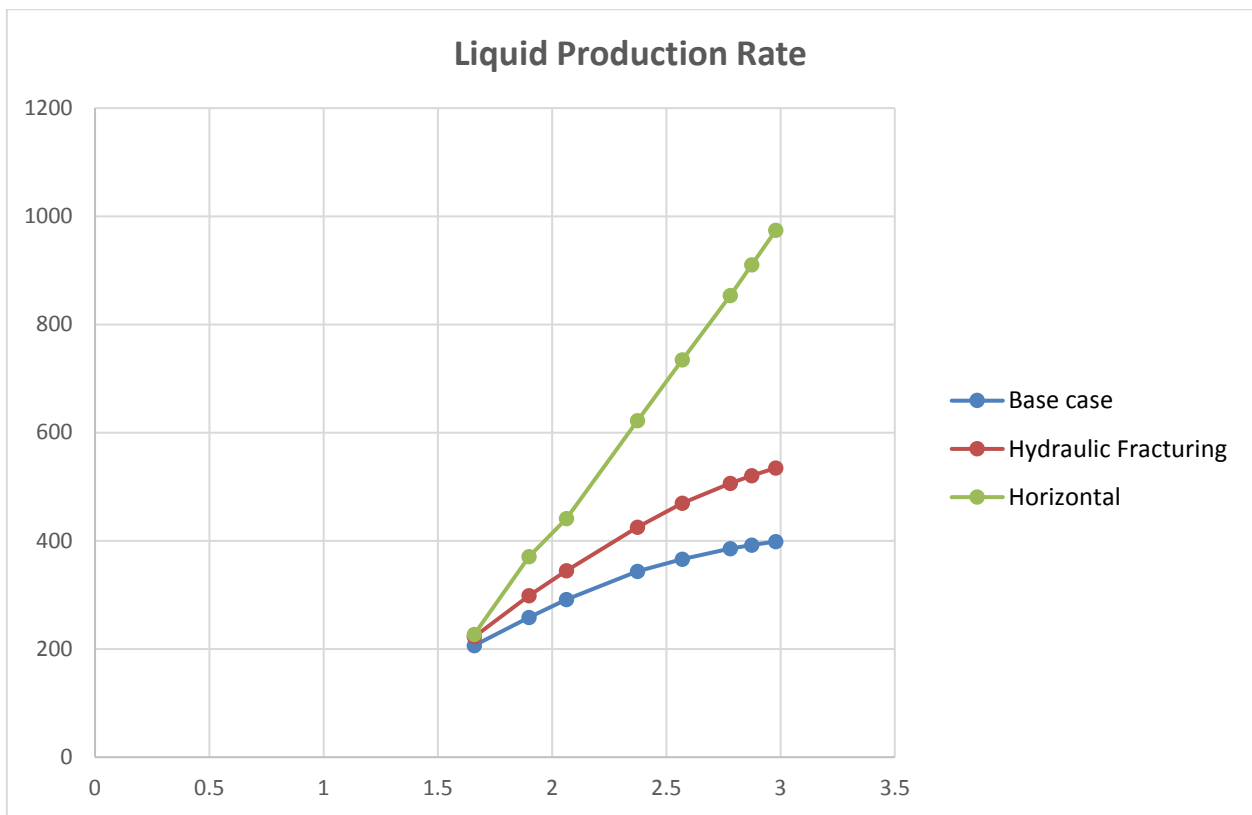
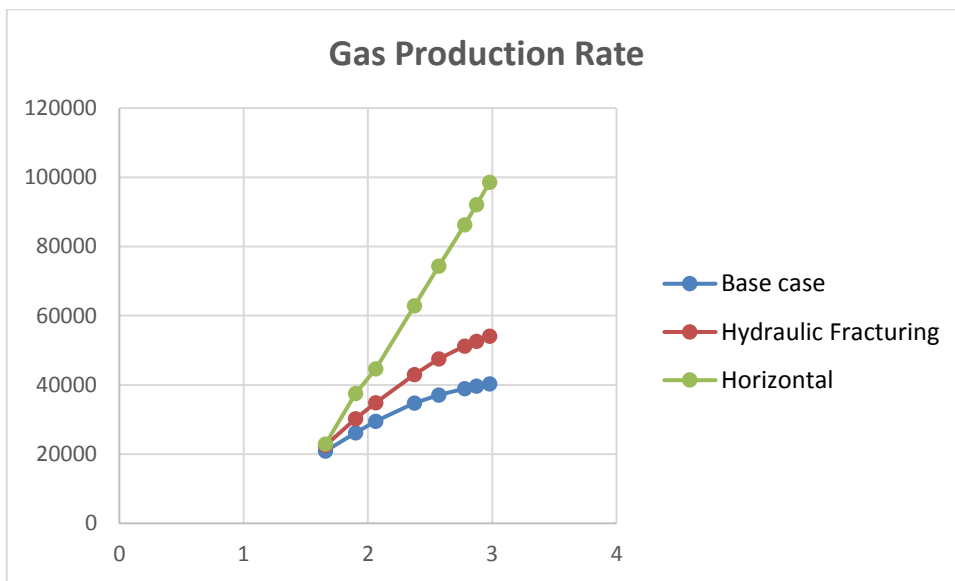

**Figure 45.** Liquid Production Rates in tubing diameter sizes in 60 angle inclination

Parameters	GUN_287_60	GUN_287_60_hydraulic_fracturing	GUN_287_60_length_of_horizontal_section
Tubing diameter (inch)	Liquid Rate (m3/day)	Liquid Rate (m3/day)	Liquid Rate (m3/day)
1,66	206,6	222,8	227,3
1,9	258,8	298,8	371
2,063	291,7	345	441,4
2,375	343,5	425,2	622,1
2,57	366,3	470	734,8
2,78	385,5	506,6	853,5
2,875	392,3	520,7	910,3
2,98	398,8	534,8	974,4

**Table 30.** Liquid Production Rates in tubing diameter sizes in 60 angle inclination

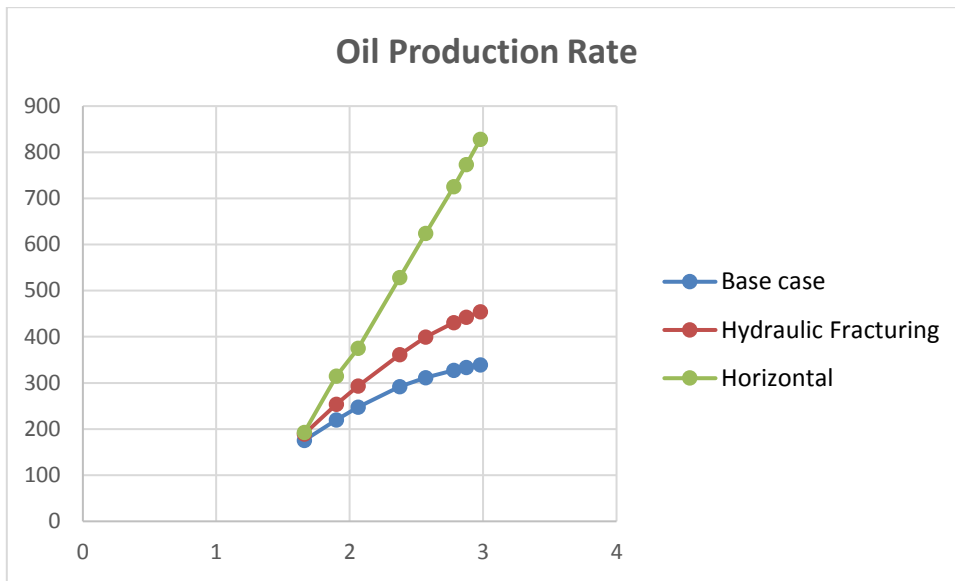



**Figure 46.** Gas Production Rates in tubing diameter sizes in 60 angle inclination

Parameters	GUN_287_60	GUN_287_60_hydraulic_fracturing	GUN_287_60_length_of_horizontal_section
Tubing diameter(inch)	Gas Rate(m3/day)	Gas Rate(m3/day)	Gas Rate(m3/day)
1,66	20898,7	22535,4	22996,3
1,9	26183	30221,2	37527
2,063	29507,3	34894,9	44652,6
2,375	34747,5	43013,9	62925,3
2,57	37056,6	47542,7	74330,9
2,78	38993,4	51240,9	86334,4
2,875	39687,8	52669	92084,2
2,98	40342,4	54093,2	98570,7

**Table 31.** Gas Production Rates in tubing diameter sizes in 60 angle inclination



**Figure 47.** Oil Production Rates in tubing diameter sizes in 60 angle inclination

Parameters	GUN_287_60	GUN_287_60_hydraulic_fracturing	GUN_287_60_length_of_horizontal_section
Tubing diameter(inch)	Oil Rate(m3/day)	Oil Rate(m3/day)	Oil Rate(m3/day)
1,66	175,6	189,4	193,2
1,9	220	253,9	315,3
2,063	247,9	293,2	375,2
2,375	292	361,4	528,8
2,57	311,4	399,5	624,6
2,78	327,7	430,6	725,5
2,875	333,5	442,6	773,8
2,98	339	454,5	828,3

**Table 32.** Oil Production Rates in tubing diameter sizes in 60 angle inclination

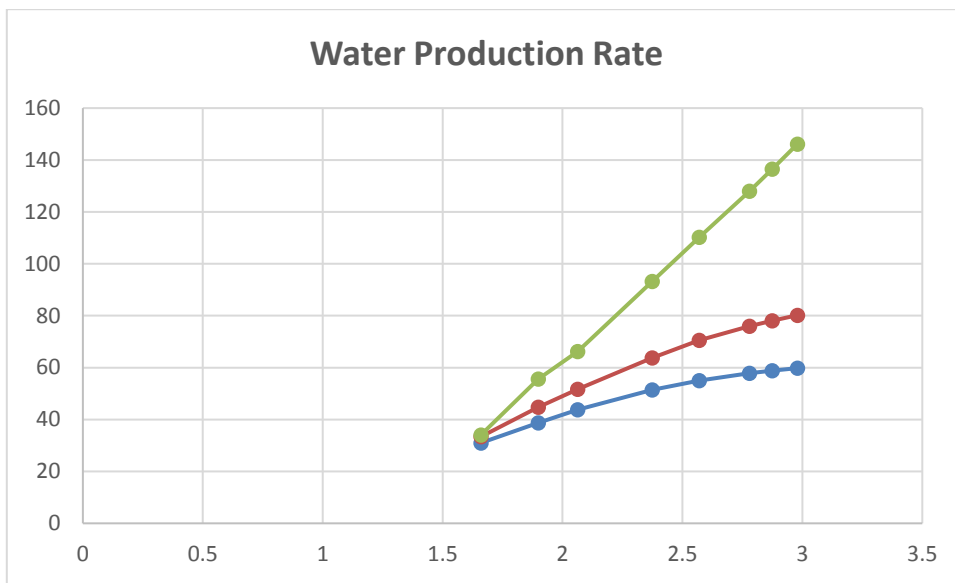

**Figure 48.** Water Production Rates in tubing diameter sizes in 60 angle inclination

Parameters	GUN_287_60	GUN_287_60_hydraulic_fracturing	GUN_287_60_length_of_horizontal_section
Tubing diameter(inch)	Water Rate(m3/day)	Water Rate(m3/day)	Water Rate(m3/day)
1,66	31	33,4	34,1
1,9	38,8	44,8	55,6
2,063	43,8	51,7	66,2
2,375	51,5	63,8	93,3
2,57	55	70,5	110,2
2,78	57,8	76	128
2,875	58,9	78,1	136,5
2,98	59,8	80,2	146,2

**Table 33.** Water Production Rates in tubing diameter sizes in 60 angle inclination

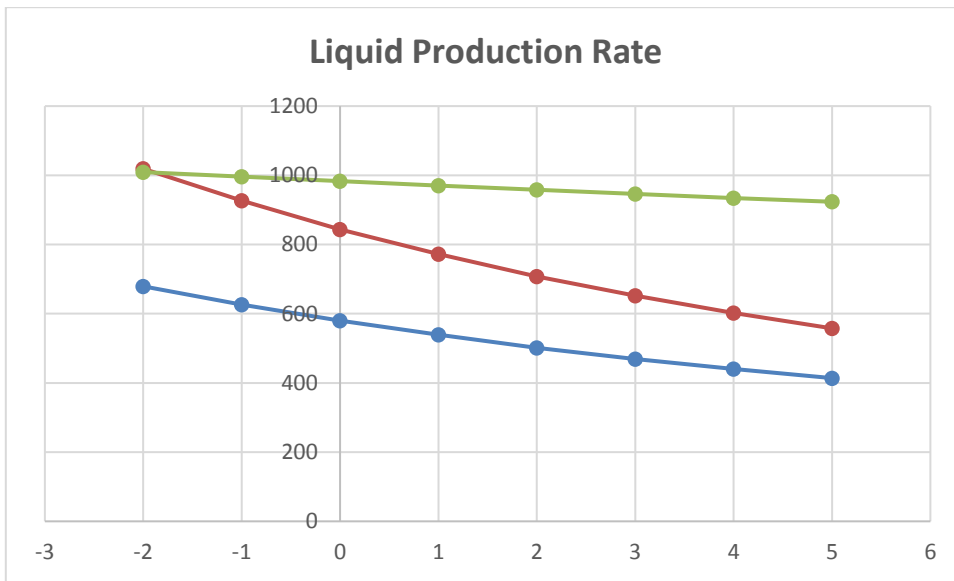

**Figure 49.** Liquid Production Rates in skin factor values in 60 angle inclination

Parameters	GUN_287_60	GUN_287_60_hydraulic_fracturing	GUN_287_60_length_of_horizontal_section
Skin factor	Liquid Rate(m <sup>3</sup> /day)	Liquid Rate(m <sup>3</sup> /day)	Liquid Rate(m <sup>3</sup> /day)
-2	679,1	1019	1009,2
-1	626,2	927,2	995,9
0	579,6	843,9	982,9
1	538,9	772,7	970,2
2	501,6	707,4	957,9
3	469,2	652,3	945,8
4	440,7	602,3	934,1
5	413,9	557,7	923,6

**Table 34.** Liquid Production Rates in skin factor values in 60 angle inclination

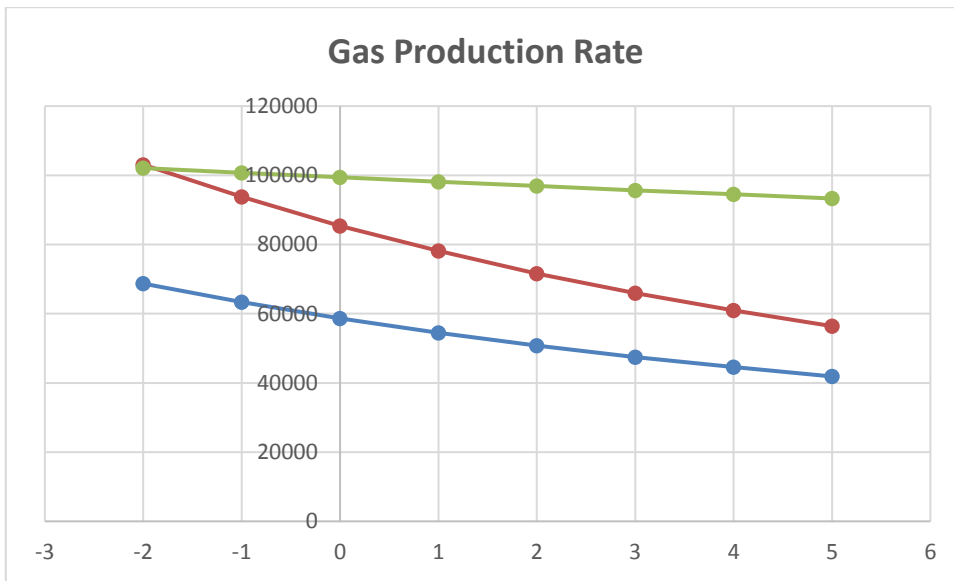
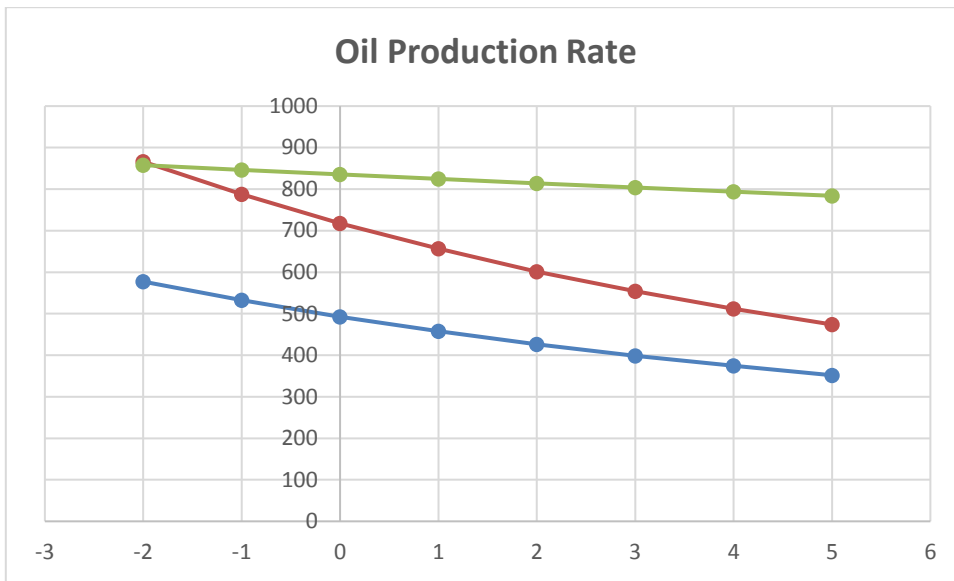

**Figure 50.** Gas Production Rates in skin factor values in 60 angle inclination

Parameters	GUN_287_60	GUN_287_60_hydraulic_fracturing	GUN_287_60_length_of_horizontal_section
Skin factor	Gas Rate(m3/day)	Gas Rate(m3/day)	Gas Rate(m3/day)
-2	68699,3	103072,8	102081,9
-1	63343,9	93789,2	100744
0	58633,2	85366,7	99427,7
1	54509,5	78161,8	98145,4
2	50741,3	71556,9	96895,6
3	47460,4	65981,4	95677,4
4	44578	60926,6	94489,3
5	41870,6	56410	93301,2

**Table 35.** Gas Production Rates in skin factor values in 60 angle inclination

In basic case drilled a 60 degree inclination, gas production rate for +5 skin is 41870.6 m<sup>3</sup>/day. For hydraulic fracturing applied rate is 56410 m<sup>3</sup>/day. For horizontal well drilled at the same inclination, rate is considered 93101.2 m<sup>3</sup>/day. If we follow table 33, we can see that how gas production rate goes to decrease in comparison with lower skin.

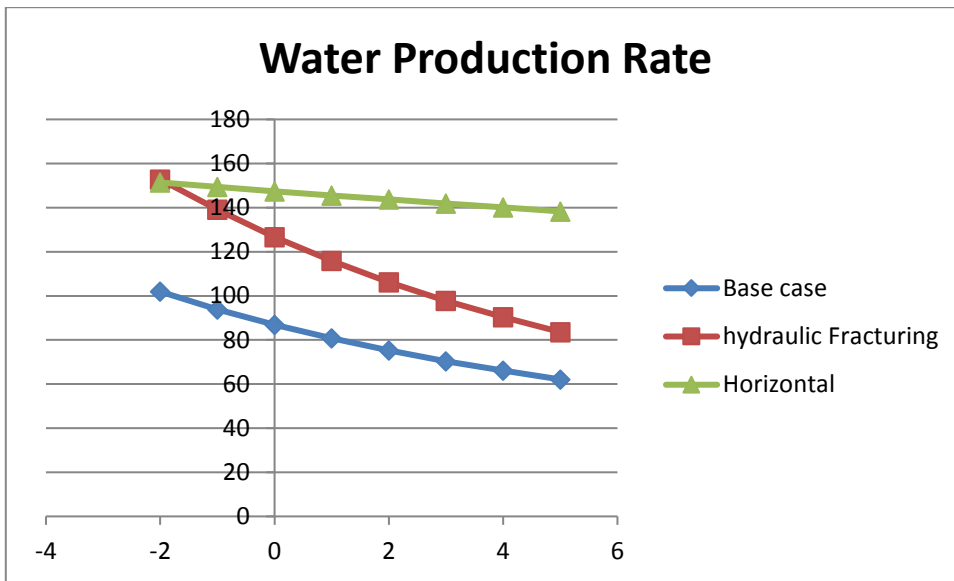

**Figure 51.** Oil Production Rates in skin factor values in 60 angle inclination

Parameters	GUN_287_60	GUN_287_60_hydraulic_fracturing	GUN_287_60_length_of_horizontal_section
Skin factor	Oil Rate(m <sup>3</sup> /day)	Oil Rate(m <sup>3</sup> /day)	Oil Rate(m <sup>3</sup> /day)
-2	577,3	866,1	857,8
-1	532,3	788,1	846,5
0	492,7	717,3	835,5
1	458	656,8	824,7
2	426,4	601,3	814,2
3	398,8	554,4	804
4	374,6	512	794
5	351,8	474	784

**Table 36.** Oil Production Rates in skin factor values in 60 angle inclination.

Oil production rate in 0 skin for the base case drilled at 60 angle inclination is determined 492.7 m<sup>3</sup>/day. Oil rate for the well hydraulic fracturing applied drilled at 60 angle is 717.3 m<sup>3</sup>/day. In horizontal well drilled at 60 degree, rate is 835.5 m<sup>3</sup>/day. As the skin increases to +5 around the wellbore, rate for base case is 351.8 m<sup>3</sup>/day, for Hf case is 474 m<sup>3</sup>/day, for horizontal well is 784 m<sup>3</sup>/day.



**Figure 52.** Water Production Rates in skin factor values in 60 angle inclination

Parameters	GUN_287_60	GUN_287_60_hydraulic_fracturing	GUN_287_60_length_of_horizontal_section
Skin factor	Water Rate(m3/day)	Water Rate(m3/day)	Water Rate(m3/day)
-2	101,9	152,8	151,4
-1	93,9	139,1	149,4
0	86,9	126,6	147,4
1	80,8	115,9	145,5
2	75,2	106,1	143,7
3	70,4	97,8	141,9
4	66,1	90,3	140,1
5	62,1	83,6	138,3

**Table 37.** Water Production Rates in skin factor values in 60 angle inclination

Water production rates in the +1 skin for base case drilled at 60 angle inclination is 80.8 m3/day. This rate changed for the well hydraulic fracturing applied at 60 degree inclination is 115.9 m3/day. In drilled horizontal well at 60 angle inclination, rate is found to be 145.5 m3/day.

## Original coordinates and depths

X	Y	MD	TVD
508331,5	4451726	0	0
508331,4	4451725	50	50
508331,1	4451725	100	99,998
508330,9	4451725	150	149,997
508330,5	4451724	200	199,994
508330	4451724	250	249,987
508329,1	4451723	300	299,972
508328	4451722	350	349,951
508326,8	4451722	400	399,933
508325,6	4451721	450	449,915
508324,5	4451721	500	499,899
508322,8	4451720	550	549,868
508320,6	4451721	600	599,818
508318,3	4451722	650	649,733
508316,4	4451725	700	699,625
508313,4	4451729	750	749,38
508309,6	4451733	800	799,056
508304,1	4451737	850	848,593
508297,2	4451741	900	897,924
508291,6	4451749	950	947,058
508288,2	4451758	1000	995,972
508284,3	4451769	1050	1044,777
508283	4451776	1100	1094,146
508281,5	4451779	1150	1144,025
508277	4451781	1200	1193,775
508272,5	4451783	1250	1243,532
508264,4	4451785	1300	1292,791
508254,1	4451792	1350	1341,208
508240,5	4451801	1400	1388,391
508224,8	4451810	1450	1435,108
508209,6	4451817	1500	1482,118
508195,2	4451825	1550	1529,484
508180,9	4451831	1600	1576,879
508166,3	4451838	1650	1624,225
508151,8	4451845	1700	1671,561
508136,6	4451853	1750	1718,545
508120,7	4451861	1800	1765,2
508104	4451870	1850	1811,555
508087,8	4451879	1900	1857,995



508072,3	4451888	1950	1904,72
508057,3	4451896	2000	1951,675
508042,5	4451904	2050	1998,737
508028	4451912	2100	2045,902
508014	4451920	2150	2093,254
508000,2	4451928	2200	2140,719
507987,4	4451935	2250	2188,507
507975,6	4451942	2300	2236,629
507964,6	4451948	2350	2284,986
507954,3	4451954	2400	2333,574
507944,7	4451959	2450	2382,336
507935,5	4451964	2500	2431,217
507927,1	4451969	2550	2480,275
507919,5	4451973	2600	2529,5
507912,6	4451977	2650	2578,865
507905,8	4451981	2700	2628,253
507899,2	4451985	2750	2677,682
507892,9	4451988	2800	2727,144
507887,3	4451991	2850	2776,743
507882,9	4451992	2900	2826,544
507879,9	4451991	2950	2876,429
507878,3	4451987	2996,9	2923,186

### Coordinates and depths after 30 degree inclination from 2600m depth

X	Y	MD	TVD
508331,5	4451726	0	0
508331,354	4451725	50	50
508331,126	4451725	100	99,998
508330,884	4451725	150	149,997
508330,549	4451724	200	199,994
508329,988	4451724	250	249,987
508329,092	4451723	300	299,972
508328,028	4451722	350	349,951
508326,795	4451722	400	399,933
508325,615	4451721	450	449,915
508324,488	4451721	500	499,899
508322,785	4451720	550	549,868
508320,617	4451721	600	599,818
508318,314	4451722	650	649,733
508316,436	4451725	700	699,625

508313,382	4451729	750	749,38
508309,554	4451733	800	799,056
508304,114	4451737	850	848,593
508297,197	4451741	900	897,924
508291,574	4451749	950	947,058
508288,182	4451758	1000	995,972
508284,346	4451769	1050	1044,777
508283,042	4451776	1100	1094,146
508281,457	4451779	1150	1144,025
508276,984	4451781	1200	1193,775
508272,459	4451783	1250	1243,532
508264,437	4451785	1300	1292,791
508254,1	4451792	1350	1341,208
508240,521	4451801	1400	1388,391
508224,759	4451810	1450	1435,108
508209,576	4451817	1500	1482,118
508195,233	4451825	1550	1529,484
508180,861	4451831	1600	1576,879
508166,304	4451838	1650	1624,225
508151,795	4451845	1700	1671,561
508136,617	4451853	1750	1718,545
508120,687	4451861	1800	1765,2
508104,046	4451870	1850	1811,555
508087,799	4451879	1900	1857,995
508072,275	4451888	1950	1904,72
508057,301	4451896	2000	1951,675
508042,529	4451904	2050	1998,737
508027,973	4451912	2100	2045,902
508013,965	4451920	2150	2093,254
508000,219	4451928	2200	2140,719
507987,408	4451935	2250	2188,507
507975,604	4451942	2300	2236,629
507964,585	4451948	2350	2284,986
507954,322	4451954	2400	2333,574
507944,674	4451959	2450	2382,336
507935,531	4451964	2500	2431,217
507927,107	4451969	2550	2480,275
507919,462	4451973	2600	2529,5
507912,6	4451977	2657,001792	2578,865
507905,81	4451981	2714,030142	2628,253
507899,241	4451985	2771,105835	2677,682
507892,882	4451988	2828,219633	2727,144
507887,253	4451991	2885,491625	2776,743
507882,914	4451992	2942,996867	2826,544

507879,897 4451991 3000,599103 2876,429  
 507878,274 4451987 3054,589436 2923,186

Coordinates and depths after 45 degree inclination from 2600m depth

X	Y	MD	TVD
508331,5	4451726	0	0
508331,4	4451725	50	50
508331,1	4451725	100	99,998
508330,9	4451725	150	149,997
508330,5	4451724	200	199,994
508330	4451724	250	249,987
508329,1	4451723	300	299,972
508328	4451722	350	349,951
508326,8	4451722	400	399,933
508325,6	4451721	450	449,915
508324,5	4451721	500	499,899
508322,8	4451720	550	549,868
508320,6	4451721	600	599,818
508318,3	4451722	650	649,733
508316,4	4451725	700	699,625
508313,4	4451729	750	749,38
508309,6	4451733	800	799,056
508304,1	4451737	850	848,593
508297,2	4451741	900	897,924
508291,6	4451749	950	947,058
508288,2	4451758	1000	995,972
508284,3	4451769	1050	1044,777
508283	4451776	1100	1094,146
508281,5	4451779	1150	1144,025
508277	4451781	1200	1193,775
508272,5	4451783	1250	1243,532
508264,4	4451785	1300	1292,791
508254,1	4451792	1350	1341,208
508240,5	4451801	1400	1388,391
508224,8	4451810	1450	1435,108
508209,6	4451817	1500	1482,118
508195,2	4451825	1550	1529,484
508180,9	4451831	1600	1576,879
508166,3	4451838	1650	1624,225
508151,8	4451845	1700	1671,561

508136,6	4451853	1750	1718,545
508120,7	4451861	1800	1765,2
508104	4451870	1850	1811,555
508087,8	4451879	1900	1857,995
508072,3	4451888	1950	1904,72
508057,3	4451896	2000	1951,675
508042,5	4451904	2050	1998,737
508028	4451912	2100	2045,902
508014	4451920	2150	2093,254
508000,2	4451928	2200	2140,719
507987,4	4451935	2250	2188,507
507975,6	4451942	2300	2236,629
507964,6	4451948	2350	2284,986
507954,3	4451954	2400	2333,574
507944,7	4451959	2450	2382,336
507935,5	4451964	2500	2431,217
507927,1	4451969	2550	2480,275
507919,5	4451973	2600	2529,5
507912,6	4451977	2669,813	2578,865
507905,8	4451981	2739,658	2628,253
507899,2	4451985	2809,561	2677,682
507892,9	4451988	2879,511	2727,144
507887,3	4451991	2949,654	2776,743
507882,9	4451992	3020,084	2826,544
507879,9	4451991	3090,632	2876,429
507878,3	4451987	3156,756	2923,186

Coordinates and depths after 60 degree inclination from 2600m depth

X	Y	MD	TVD
508331,5	4451726	0	0
508331,4	4451725	50	50
508331,1	4451725	100	99,998
508330,9	4451725	150	149,997
508330,5	4451724	200	199,994
508330	4451724	250	249,987
508329,1	4451723	300	299,972
508328	4451722	350	349,951
508326,8	4451722	400	399,933
508325,6	4451721	450	449,915
508324,5	4451721	500	499,899

508322,8	4451720	550	549,868
508320,6	4451721	600	599,818
508318,3	4451722	650	649,733
508316,4	4451725	700	699,625
508313,4	4451729	750	749,38
508309,6	4451733	800	799,056
508304,1	4451737	850	848,593
508297,2	4451741	900	897,924
508291,6	4451749	950	947,058
508288,2	4451758	1000	995,972
508284,3	4451769	1050	1044,777
508283	4451776	1100	1094,146
508281,5	4451779	1150	1144,025
508277	4451781	1200	1193,775
508272,5	4451783	1250	1243,532
508264,4	4451785	1300	1292,791
508254,1	4451792	1350	1341,208
508240,5	4451801	1400	1388,391
508224,8	4451810	1450	1435,108
508209,6	4451817	1500	1482,118
508195,2	4451825	1550	1529,484
508180,9	4451831	1600	1576,879
508166,3	4451838	1650	1624,225
508151,8	4451845	1700	1671,561
508136,6	4451853	1750	1718,545
508120,7	4451861	1800	1765,2
508104	4451870	1850	1811,555
508087,8	4451879	1900	1857,995
508072,3	4451888	1950	1904,72
508057,3	4451896	2000	1951,675
508042,5	4451904	2050	1998,737
508028	4451912	2100	2045,902
508014	4451920	2150	2093,254
508000,2	4451928	2200	2140,719
507987,4	4451935	2250	2188,507
507975,6	4451942	2300	2236,629
507964,6	4451948	2350	2284,986
507954,3	4451954	2400	2333,574
507944,7	4451959	2450	2382,336
507935,5	4451964	2500	2431,217
507927,1	4451969	2550	2480,275
507919,5	4451973	2600	2529,5

507912,6	4451977	2698,73	2578,865
507905,8	4451981	2797,506	2628,253
507899,2	4451985	2896,364	2677,682
507892,9	4451988	2995,288	2727,144
507887,3	4451991	3094,486	2776,743
507882,9	4451992	3194,088	2826,544
507879,9	4451991	3293,858	2876,429
507878,3	4451987	3387,372	2923,186

## Conclusions

For increasing the drainage area of the well, horizontal wells are effective than vertical wells because the well occupies greater pay zone. The two interpretations of transient flow was used concept of definition transient drainage area: the concept of radius of investigation and concept of definition of effective transient drainage area. For simulation mentioned issues we used real data from well#287 of the Shallow Water Gunashli field using Prosper software.

Initial analyses of the production was carried out in the different tubing diameters.

- Oil production rates increase from  $246,4 \text{ m}^3/\text{day}$  to  $454,5 \text{ m}^3/\text{day}$  in 2.98 inch of tubing. Cause of production increase is to increase inclination of the well into pay zone. Result of production analyses identifies that how most inclination angle of well is drilled, greater production rates were obtained.
- Consequently, gas production rates give significant rise from  $29239 \text{ m}^3/\text{day}$  to  $54093.2 \text{ m}^3/\text{day}$  in the same tubing sizes while inclination angle was risen from 30 degree to 60 degree.

Second part of the analyses was implemented in different skin values.

- As from tables, while inclination angle of the well ranges from 30 degree to 60, gas production rates change from  $68125,9 \text{ m}^3/\text{day}$  to  $103072,8 \text{ m}^3/\text{day}$  in the value of -2 skin value. Higher tubing diameter and negative skin result in increase of production twice.
- The effect of the increase in inclination angle from 30 to 60 degree, oil production rates change from  $572,5 \text{ m}^3/\text{day}$  to  $866,1 \text{ m}^3/\text{day}$  in the -2 skin value.

Summarizing the result of whole experiment, it is understood that higher inclination

angle, greater tubing diameter and negative skin value result in the higher production rates from the well.



## References

- [1] - Hobart M. King, Ph.D., RPG ,(https://geology.com/articles/horizontal-drilling/)
- [2] - https://wiki.aapg.org/Well\_types
- [3] - Heriot Watt Production Technology 2013. “Artificial lift overview”, “Formation damage”, page 169-171, 414-415
- [4] - Jonathan Bellarby, “Well Completion Design”, 2009. “Artificial Lift”, page 304-363
- [5] - Robert S. Schechter, W.A (Monty) Moncrief Endowed Chair in Petroleum Engineering. “Oil Well Stimulation”, 2013. “Origins of the formation Damage”, page 121-129,246-249
- [6] - Reed, M.G. “Formation Damage Prevention During Drilling and Completion”, October of 1989, page 33-38.
- [6] - Trimble and Nelson, M.D. "Use of Invert Emulsion Mud Proves Successful in Zones Susceptible to Water Damage", JPT. February (1960), page 23-30.
- [8] - Jeff, H., Thomas, G. and Nelson, C. "An Integrated Long-Term Solution for Migratory Fine Damage", April of 2003, page 1-11 .
- [9] - Muecke, T.W. “Formation Fines and Factors Controlling their movement in Porous Media”. February of 1979, page 144-150.
- [10] - Civan, F. "A Multi-Phase Mud Filtrate Invasion and Well Bore Filter Cake Formation Model", October of 1994, page 399-412.
- [11] - McLeod, H.O. 1986. Matrix Acidizing to Improve Well Performance.
- [12] - Gidley, J.L. 1985. Acidizing Sandstone Formations: A Detailed Examination of Recent Experience.
- [13] - Nitters, G., Roodhart, L., Jongma, H. et al. 2000. Structured Approach to Advanced Candidate Selection and Treatment Design of Stimulation Treatments.
- [14] - Ryan keys, matrix acidizing of heterogeneous carbonates: the effect of

heterogeneity on matrix acidizing of carbonate rocks, 2011

[15] - Brezinski, M.M. 1999. Chelating Agents in Sour Well Acidizing: Methodology or Mythology

[16] - Willis, M. H. (1957). Mechanics of Hydraulic Fracturing, page 153-168

[17] - John L. Gidley, S. A. (1990). Recent Advances in Hydraulic Fracturing SPE Monograph Volume 12, Henry L.

[18] - M. M. RAHMAN and M. K. RAHMAN, "A Review of Hydraulic Fracture Models and Development of an Improved Pseudo-3D Model for Stimulating Tight Oil/Gas Sand" 2010.

[19] – Michael J. Economides, K. G., 2000. Reservoir Stimulation, 3rd Edition .

[20] - F. Liang, M. Ghaithan and F. F. Chang, "Overview of Existing Proppant